

# HygroVUE™ 10

Temperature and Relative  
Humidity Sensor



# Table of contents

---

<b>1. Introduction</b> .....	<b>1</b>
<b>2. Precautions</b> .....	<b>1</b>
<b>3. Initial inspection</b> .....	<b>1</b>
<b>4. QuickStart</b> .....	<b>2</b>
<b>5. Overview</b> .....	<b>5</b>
<b>6. Specifications</b> .....	<b>5</b>
6.1 Temperature measurement .....	6
6.2 Relative humidity measurement .....	6
<b>7. Installation</b> .....	<b>7</b>
7.1 Wiring to data logger .....	7
7.2 Data logger programming .....	8
7.3 CRBasic programming .....	9
7.4 Siting .....	9
7.4.1 Installation in a radiation shield .....	10
7.4.2 Mount the shield .....	11
<b>8. Operation</b> .....	<b>12</b>
8.1 Sensor measurement .....	12
8.2 Measurements in programs with fast scan rates .....	14
8.3 Long cables .....	14
8.4 Power conservation .....	15
8.5 Measuring multiple SDI-12 sensors .....	15
<b>9. Troubleshooting and maintenance</b> .....	<b>15</b>
9.1 Troubleshooting .....	16
9.2 Maintenance .....	16
9.3 Calibration .....	17
9.4 Sensor element replacement .....	17

<b>10. Attributions and references</b> .....	<b>20</b>
<b>Appendix A. Importing Short Cut code into CRBasic Editor</b> .....	<b>21</b>
<b>Appendix B. CRBasic example program</b> .....	<b>22</b>
<b>Appendix C. Environmental performance</b> .....	<b>24</b>
C.1 Exposure to pollutants .....	24
C.2 Operating range of the RH element .....	24
C.3 Measurement below 0 °C .....	25
<b>Appendix D. SDI-12 sensor support</b> .....	<b>26</b>
D.1 SDI-12 command basics .....	26
D.1.1 Acknowledge active command (a!) .....	27
D.1.2 Send identification command (a!) .....	27
D.1.3 Start verification command (aV!) .....	28
D.1.4 Address query command (?!) .....	28
D.1.5 Change address command (aAb!) .....	28
D.1.6 Start measurement commands (aM!) .....	29
D.1.7 Start concurrent measurement commands (aC!) .....	29
D.1.8 Start measurement commands with cyclic redundancy check (aMC! and aCC!) .....	31
D.1.9 Stopping a measurement command .....	31
D.1.10 Send data command (aD0! ... aD9!) .....	31
D.1.11 Continuous measurement command (aR0! ... aR9!) .....	32
D.2 References .....	32
D.3 SDI-12 transparent mode .....	32
D.3.1 Changing an SDI-12 address .....	33
<b>Appendix E. Sensor element calibration</b> .....	<b>36</b>

# 1. Introduction

---

The HygroVUE™10 Temperature and Relative Humidity Sensor is designed for general meteorological and environmental applications. It is part of a range of HygroVUE sensors. The HygroVUE sensors feature a low maintenance design with a highly stable and accurate replaceable RH chip that will lower the total cost of deployment throughout a network. The HygroVUE 10 uses the SDI-12 communications protocol to communicate with any SDI-12 recorder, simplifying wiring and programming.

## 2. Precautions

---

- READ AND UNDERSTAND the [Safety](#) section at the back of this manual.
- When opening the shipping package, do not damage or cut the cable jacket. If damage to the cable is suspected, consult with a Campbell Scientific support engineer.
- Although rugged, the HygroVUE 10 should be handled as a precision scientific instrument.



## 3. Initial inspection

---

- Check the packaging and contents of the shipment. If damage occurred during transport, immediately file a claim with the carrier. Contact Campbell Scientific to facilitate repair or replacement.
- Check model information against the shipping documents to ensure the expected products and the correct lengths of cable are received. Model numbers are found on each product. On cables and cabled items, the model number is usually found at the connection end of the cable. Report any shortages immediately to Campbell Scientific.

# 4. QuickStart

A video that describes data logger programming using *Short Cut* is available at:

[www.campbellsci.com/videos/cr1000x-data-logger-getting-started-program-part-3](http://www.campbellsci.com/videos/cr1000x-data-logger-getting-started-program-part-3) . *Short Cut* is an easy way to program your data logger to measure the sensor and assign data logger wiring terminals. *Short Cut* is available as a download on [www.campbellsci.com](http://www.campbellsci.com) . It is included in installations of *LoggerNet*, *RTDAQ*, and *PC400*.

The following procedure also shows using *Short Cut* to program the sensor.

1. Open *Short Cut* and click **Create New Program**.
2. Double-click the data logger model.
3. In the **Available Sensors and Devices** box, type HygroVUE10 or locate the sensor in the **Sensors > Meteorological > Relative Humidity & Temperature** folder. Double-click **HygroVUE5/HygroVUE10 Temperature & Relative Humidity Sensor**. Temperature units default to degrees Celsius. This can be changed by clicking the **Deg C** box and selecting **Deg F**, for degrees Fahrenheit, or **K** for Kelvin. **SDI-12 Address** defaults to 0. Enter the correct **SDI-12 Address** for the HygroVUE 10 if it has been changed from the factory-set default value.

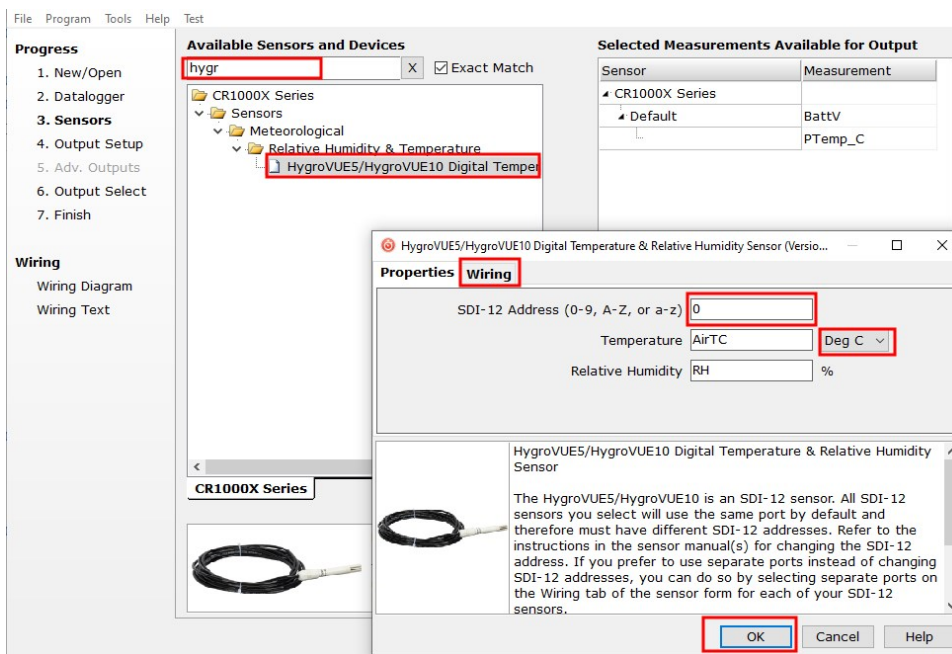

- Click the **Wiring** tab to see how the sensor is to be wired to the data logger. The default control terminal for SDI-12 is **C1**. To change to another terminal, click the terminal name and select another terminal. Click **OK** after wiring the sensor.

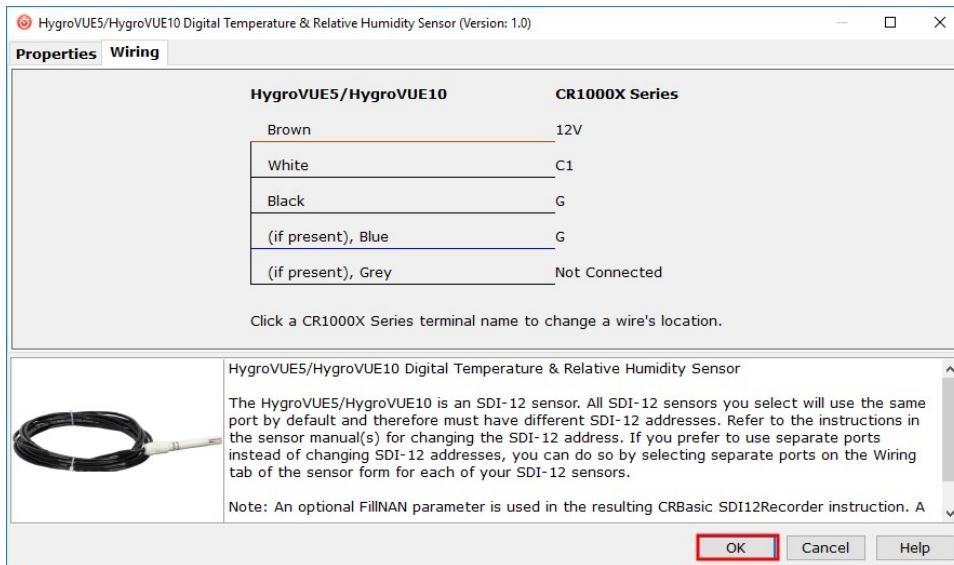

- Repeat steps three and four for other sensors you want to measure. Click **Next**.
- In **Output Setup**, type the scan rate (5 seconds or longer), meaningful table names, and the **Data Output Storage Interval**. Click **Next**.

**NOTE:**

Making measurements from the HygroVUE 10 more frequently than 5 seconds can result in small additional errors due to self-heating of the element. If the main scan rate needs to be faster than this, please read [Sensor measurement](#) (p. 12) and [Measurements in programs with fast scan rates](#) (p. 14) about alternate programming techniques.

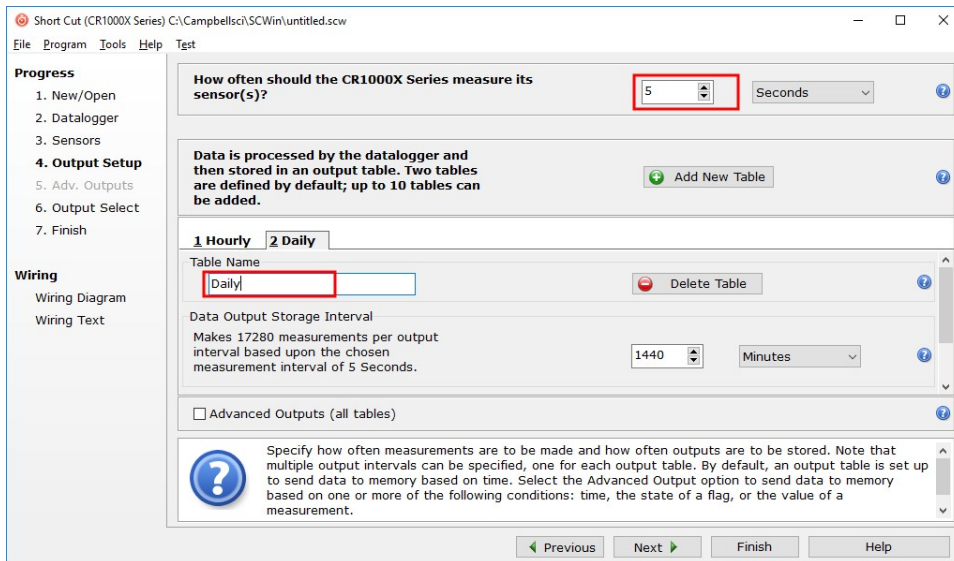

7. Select the measurement and its associated output option.

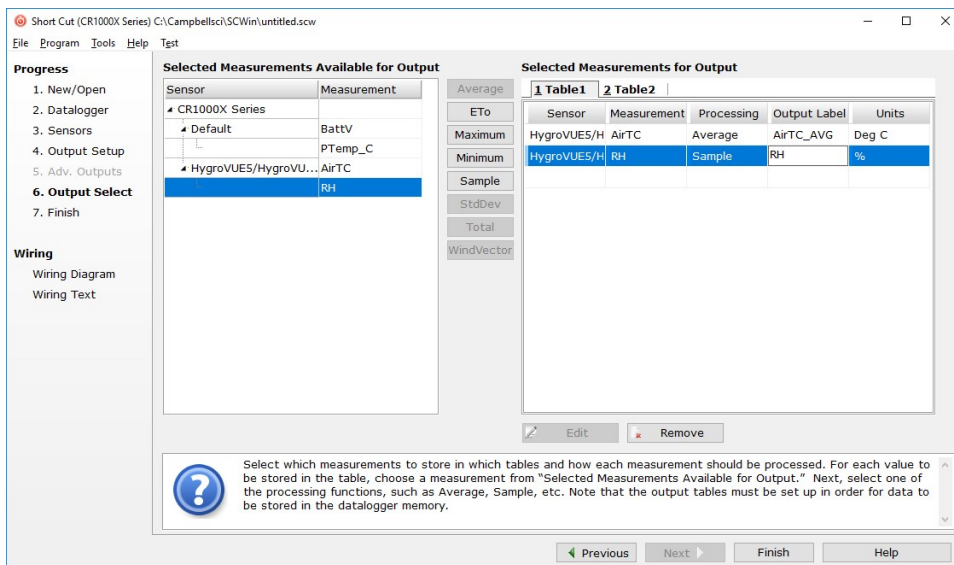

8. Click **Finish** and save the program. Send the program just created to the data logger if the data logger is connected to the computer.
9. If the sensor is connected to the data logger, check the output of the sensor in the data display in *LoggerNet*, *RTDAQ*, or *PC400* to make sure it is making reasonable measurements.

# 5. Overview

---

The HygroVUE 10 sensor uses a single chip element that incorporates both a temperature and an RH sensor. Each element is individually calibrated with the calibration corrections stored on the chip. The element is easily changed in the field, reducing downtime and calibration costs.

Electronics within the HygroVUE 10 control the measurement made by the sensor element, apply temperature and linearization corrections to the readings, and present the data via SDI-12 to a data logger.

A stainless steel mesh filter minimizes the effects of dust and dirt on the sensor while allowing air exchange around the sensor element and reducing the chances of condensation remaining inside the filter cap. A small PTFE membrane filter is bonded to the surface of the element which prevents any finer dust or mold from directly influencing the measurement.

The sensor housing is designed to withstand permanent exposure to all weather and to fit into a range of radiation shields, including compact shields.

# 6. Specifications

---

<b>Compatibility:</b>	Fully SDI-12 V1.3-compliant digital output (verified with an SDI-12 Verifier ( <a href="http://www.sdi-12-verifier.com">www.sdi-12-verifier.com</a>  )). Compatible with SDI-12 V1.4 recorders including Campbell Scientific CR6, CR3000, CR1000X, CR800-series, CR300-series, and CR1000 data loggers
<b>Sensor element:</b>	Sensirion SHT35 derivative
<b>Calibration traceability:</b>	NIST and NPL standards. See <a href="#">Sensor element calibration</a> (p. 36) for details of calibration traceability.
<b>Supply voltage:</b>	7 to 28 VDC
<b>Current consumption:</b>	50 $\mu$ A quiescent, typical 0.6 mA during 0.5 s measurement typical
<b>Warm-up time:</b>	Sensor normally powered all the time, if power is switched allow 1.8 s for sensor power-up.
<b>Diameter:</b>	12.5 mm (0.49 in) at sensor tip, maximum 18 mm (0.7 in) at connector



<b>Length:</b>	180 mm (7.1 in), sensor only, without cable
<b>Sensor body weight:</b>	50 g (1.8 oz)
<b>Weight:</b>	250 g (8.8 oz) with 5 m (16.4 ft) cable
<b>Housing material:</b>	White PET-P
<b>Housing classification:</b>	IP67 (electronics housing)
<b>Sensor protection:</b>	Outer glass-filled polypropylene cap fitted with a stainless steel mesh dust filter with nominal pore size of <math><30\ \mu\text{m}</math>. The sensor element is fitted with a PTFE protective film with a filtration efficiency of >99.99% for particles of 200 nm or larger size.
<b>Sensor cable connector:</b>	M12, male, 4-pole, A-coded
<b>EMC compliance:</b>	Tested and conforms to IEC61326:2013
<b>Calibration:</b>	The sensor element is individually calibrated during manufacture.
<b>Compliance documents:</b>	View at <a href="http://www.campbellsci.com/hygrovue10">www.campbellsci.com/hygrovue10</a> 

## 6.1 Temperature measurement

<b>Operating range:</b>	-40 to 70 °C
<b>Accuracy*:</b>	$\pm 0.2\ \text{°C}$ (-40 to 70 °C) $\pm 0.1\ \text{°C}$ (20 to 60 °C)
<b>Long term drift:</b>	<math><\pm 0.03\ \text{°C/year}</math>
<b>Reported resolution:</b>	0.001 °C
<b>Repeatability**:</b>	0.04 °C
<b>Response time:</b>	130 s (63% response time in air moving at 1 m/s)
<b>Units:</b>	Degrees Celsius

\*The accuracy figures quoted are relative to factory standards.

\*\*Values are 3 standard deviations of 25 measurements at constant temperature.

## 6.2 Relative humidity measurement

<b>Operating range:</b>	0 to 100% RH
<b>Accuracy (at 25°C)*:</b>	$\pm 1.5\%$ (0 to 80% RH) $\pm 2\%$ (80 to 100% RH)

Temperature dependence:	< ±1% RH (–40 to 60 °C)
Short term hysteresis:	< ±1% RH
Long-term stability:	±0.5% per year (drift in clean air conditions)
Reported resolution:	0.001% RH
Repeatability**:	0.05% RH
Response time with filter:	8 s (63% response time in air moving at 1 m/s @ 25 °C)
Environmental performance:	See <a href="#">Environmental performance</a> (p. 24)

\*The accuracy figures quoted are relative to factory standards.

\*\*Values are 3 standard deviations of 25 measurements at constant humidity.

## 7. Installation

If you are programming your data logger with *Short Cut*, skip [Wiring to data logger](#) (p. 7) and [Data logger programming](#) (p. 8). *Short Cut* does this work for you. See [QuickStart](#) (p. 2) for a *Short Cut* tutorial.

### 7.1 Wiring to data logger

The sensor has an industry-standard M12 connector for attaching the cable. The wiring of the sensor is shown in [Table 7-1](#) (p. 7).

Pin	Wire color	Wire function	Data logger connection terminal
1	Brown	Power	12V
2	White	SDI-12	C terminal or U terminal configured for SDI-12 <sup>1</sup>
3	Black	Power ground	G
	Clear	Shield	G

<sup>1</sup>U terminals are automatically configured by the measurement instruction.

To use more than one sensor per data logger, either connect the different sensors to different terminals on the data logger or change the SDI-12 addresses of the sensors and wire them to the same terminal. Using the SDI-12 address reduces the use of terminals on the data logger and

allows sensors to be connected in a daisy-chain fashion that can minimize cable runs in some applications. (See [Long cables](#) (p. 14) for limits on the total cable length.)

For the CR6 and CR1000X, triggering conflicts may occur when a companion terminal is used for a triggering instruction such as [TimerInput\(\)](#), [PulseCount\(\)](#), or [WaitDigTrig\(\)](#). For example, if the HygroVUE 10 is connected to C3 on a CR1000X, C4 cannot be used in the [TimerInput\(\)](#), [PulseCount\(\)](#), or [WaitDigTrig\(\)](#) instructions.

The SDI-12 address of the HygroVUE 10 can be set two ways:

- by sending the required commands to the sensors via an SDI-12 recorder/data logger that allows talk through to the sensor.
- by loading a program into the recorder that sends the required commands.

See [SDI-12 sensor support](#) (p. 26) for detailed instructions.

## 7.2 Data logger programming

**Short Cut** is the best source for up-to-date programming code for Campbell Scientific data loggers. If your data acquisition requirements are simple, you can probably create and maintain a data logger program exclusively with **Short Cut**. If your data acquisition needs are more complex, the files that **Short Cut** creates are a great source for programming code to start a new program or add to an existing custom program.

### NOTE:

**Short Cut** cannot edit programs after they are imported and edited in *CRBasic Editor*.

A **Short Cut** tutorial is available in [QuickStart](#) (p. 2). If you wish to import **Short Cut** code into *CRBasic Editor* to create or add to a customized program, follow the procedure in [Importing Short Cut code into CRBasic Editor](#) (p. 21). Programming basics for CRBasic data loggers are provided in the following section. A complete program example can be found in [CRBasic example program](#) (p. 22).

### NOTE:

Making measurements from the HygroVUE 10 more frequently than every 5 seconds can result in small additional errors due to self-heating of the element. If the main scan rate needs to be faster than this please read [Sensor measurement](#) (p. 12) and [Measurements in programs with fast scan rates](#) (p. 14) about alternate programming techniques.

## 7.3 CRBasic programming

The [SDI12Recorder\(\)](#) instruction is used to measure a HygroVUE 10 configured for SDI-12 measurements. The [SDI12Recorder\(\)](#) instruction sends a request to the sensor to make a measurement and then retrieves the measurement from the sensor. See [Sensor measurement](#) (p. 12) for more information.

For most data loggers, the [SDI12Recorder\(\)](#) instruction has the following syntax:

```
SDI12Recorder(Destination, SDIPort, SDIAddress, "SDICommand", Multiplier, Offset, FillNAN, WaitonTimeout)
```

Valid values for the **SDIAddress** are 0 through 9, A through Z, and a through z; alphabetical characters need to be enclosed in quotes (for example, "A"). Also enclose the **SDICommand** in quotes as shown. The **Destination** parameter must be an array. The required number of values in the array depends on the command (see [Table 8-1](#) (p. 13)).

**FillNAN** and **WaitonTimeout** are optional parameters (refer to CRBasic Help for more information).

## 7.4 Siting

The general EPA guidance for standard meteorological stations is to locate the sensor over an open, level area at least 9 m (29.5 ft) in diameter. The surface should be covered by short grass or the natural earth surface where grass does not grow. Sensors should be located at a distance of at least four times the height of any nearby obstruction and at least 30 m (98.4 ft) (EPA) from large, paved areas. Sensors should be protected from thermal radiation and adequately ventilated. Protect the filter at the top of the sensor from exposure to liquid water.

The sensor should be installed at a standard measurement height which varies depending on the guides being used:

- 1.5 m (4.92 ft) (AASC)
- 1.25 to 2.0 m (4.1 to 6.5 ft) (WMO)
- 2.0 m (6.5 ft) (EPA)

See [Attributions and references](#) (p. 20) for a list of references that discuss temperature and relative humidity sensors.

When used in the field, the HygroVUE 10 must be housed in a radiation shield. Typically, the RAD10E or RAD14 unventilated or the TS100SS fan-aspirated solar radiation shield is used.

The white color of these shields reflects solar radiation, and the louvered construction allows air to pass freely through, thereby keeping the sensor at or near ambient temperature. The RAD10E

or RAD14 uses a double-louvered design that offers improved sensor protection from insect intrusion and driving rain and snow. In addition, compared to shields of a similar appearance, the RAD shields have lower self-heating in bright sunlight combined with low wind speeds giving a better measurement. The RAD14 shield, performs slightly better in these conditions than the smaller RAD10E shield.

The Apogee Instruments aspirated TS100SS shield can also be used where minimal solar errors and a fast speed of response is desired. A special adapter is available to allow the HygroVUE 10 to fit within the shield. Please refer for the documentation for that shield for further installation instructions.

Each of these solar radiation shields attaches to a crossarm, mast, or user-supplied pipe with a 2.5 to 5.3 cm (1.0 to 2.1 inch) outer diameter.

Tools required for installing a radiation shield to a tripod or tower include:

- adjustable wrench (to suit 12 mm (1/2 in) nuts)
- small screwdriver provided with data logger
- small Phillips screwdriver
- UV-resistant cable ties
- small pair of diagonal-cutting pliers
- adjustable wrench with a minimum 50 mm (2 in) jaw size.

## 7.4.1 Installation in a radiation shield

1. Loosen the nut on the entry gland at the bottom of the shield.
2. Insert the sensor into the gland. See [FIGURE 7-1](#) (p. 11). The sensor should be pushed into the shield so the tip of the sensor is approximately one third of the way down from the top of the shield, or as far as it can be pushed in if using the 14-plate shield.
3. First tighten the nut on the gland by hand until the sensor is held firmly in place. Ensure the gland tightens on the white body of the sensor, not the connector. Then use the large adjustable wrench to further tighten the gland by 1/2 to 1 turn. Do not overtighten the nut as you risk damaging the sensor body and also making service of the sensor more difficult in the future.



*FIGURE 7-1. Cut away view shows HygroVUE 10 insertion in a RAD shield*

## 7.4.2 Mount the shield

1. Attach the radiation shield to the tripod mast, crossarm, or tower leg using the supplied U-bolt or band clamp. See [FIGURE 7-2](#) (p. 12) for an example of shield mounting.
2. Connect the cable to the sensor.
3. Route the cable to the data logger, and secure the cable to the mounting structure using cable ties.

**CAUTION:**

Failure to secure the cable can lead to breakage of the wires due to fatigue caused by blowing back and forth in the wind.



FIGURE 7-2. HygroVUE 10 installed in a RAD10E radiation shield on a pole

## 8. Operation

---

8.1 Sensor measurement .....	12
8.2 Measurements in programs with fast scan rates .....	14
8.3 Long cables .....	14
8.4 Power conservation .....	15
8.5 Measuring multiple SDI-12 sensors .....	15

### 8.1 Sensor measurement

The CRBasic instruction [SDI12Recorder\(\)](#) measures the HygroVUE 10 sensor using the Start Measurement (**M**), Concurrent Measurement (**C**), or Continuous Measurement (**R**) commands. The SDI-12 commands relevant to taking measurements are shown in [Table 8-1](#) (p. 13). [SDI-12 sensor support](#) (p. 26) describes all the SDI-12 commands that are supported. Additional SDI-12 information is available at [www.sdi-12.org](http://www.sdi-12.org) .

Table 8-1: HygroVUE 10 SDI-12 measurement commands	
SDI-12 Command (a is the address)	Values returned
aM!, aC!, aR0!, aMC!, aCC!, aR0C!	Temperature (°C), relative humidity (%)
aM1!, aR1!, aMC1!, aRC1!	Dewpoint (°C) of the air
aM3!, aR3!, aMC3!, aRC3!	Temperature (°C), relative humidity (%), dewpoint (°C), and vapor pressure (kPa)

When entering the command in a CRBasic program the address is entered as a separate parameter in the command. The SDI-12 command is entered in a different parameter as a string, excluding the address but including the terminator character (for example "M!").

When a measurement is initiated with the **M** or **C** commands the sensor responds with the maximum time delay until the measurements are available and the number of values to be returned. The delay is 1 second for this sensor. For the **M** commands, Campbell Scientific data loggers interprets the response and automatically sends one or more **D** commands after the sensor indicates data is ready to read the data from the sensor and write it to the results variable. The whole measurement normally delays the data logger by about 400 milliseconds with the standard **M** command.

The **C** command differs in that the data logger does not wait after sending the command and continues with other instructions in the program. It automatically collects the data the next time the **SDIRecorder()** instruction runs in the next scan. This allows measurements for several different sensors to be triggered and made concurrently but the measurements seen in the data logger are effectively one scan period old. For the HygroVUE 10 this instruction is rarely used because the instruction takes longer to execute than the **M** or **R** commands.

The **R** command switches the sensor to automatically make measurements every 10 seconds, based on the sensor internal clock. Note this command must be entered as **R0** (a single R alone is invalid). For the data logger this instruction usually takes less than 220 milliseconds to execute so this causes the least delay to program execution. However, for programs which operate with scans longer than 10 seconds the power consumption by the sensor will be higher when using this mode of operation. The automatic measurement mode and its consequent power consumption can only be canceled by powering down the sensor to reset it.

With the standard commands (**M**, **C**, and **R0**) the sensor returns two values: temperature (°C) and relative humidity as a percentage (0 to 100). The sensor also supports some additional variants of the measurement commands; see [Table 8-1](#) (p. 13).



Dewpoint and vapor pressure are calculated using formula from:

Alduchov, O. A., and R. E. Eskridge, 1996: Improved Magnus form approximation of saturation vapour pressure. *J. Appl Meteor.*, 35, 601-609.

These optional outputs are provided mainly for non-Campbell data logger applications. Campbell data loggers have built in functions to calculate these derived variables and making the calculations in the data logger will be quicker and take less power as it takes the sensor much longer to perform the calculations required than the data logger.

The HygroVUE 10 also supports the **MC**, **CC**, and **RC** instructions, which are the same as the **M**, **C**, and **R** instructions, but a cyclic redundancy check (CRC) is added that validates the data. Use of the checksum option is only normally necessary for long cable runs.

The factory-set SDI-12 address for the HygroVUE 10 is 0. See [Change address command \(aAb!\)](#) (p. 28) for instructions on changing the SDI-12 address through the data logger. [SDI-12 sensor support](#) (p. 26) all give full details of the additional commands and details of the SDI-12 protocol.

## 8.2 Measurements in programs with fast scan rates

Calling the [SDI12Recorder\(\)](#) instruction in a [SlowSequence\(\)](#) allows the SDI-12 instruction to run as a background process, causing minimum interference to other measurements that use other hardware in the data logger. Code and measurements that need to run at higher speeds can run in the main scan.

## 8.3 Long cables

Digital data transfer eliminates offset and noise errors due to cable lengths. However, digital communications can break down when cables are too long, resulting in either no response from the sensor or corrupted readings. The original SDI-12 standard specifies the maximum total cable length of 60 meters (200 ft). Low power SDI-12 sensors such as the HygroVUE 10 have been used with longer cables up to 300 m (1000 ft). This model of sensor is normally only supplied with cables up to 10 m in length. If the cable is to be extended, follow these guidelines:

- Use low capacitance, low resistance, screened cable (as fitted by Campbell Scientific) to reach distances of several hundred meters.
- Ensure that the power ground cable has low resistance and is connected to the same ground reference as the data logger control ports.

- Be aware that “daisy-chaining” or connecting sensors in parallel to the same SDI-12 port reduces the total cable length roughly in proportion to the number of sensors connected. For example, while it may be possible to use one cable run of 300 m (1000 ft) to a single sensor, the cable length would be limited to around 100 m (300 ft) per sensor if three sensors are connected to one port.

## 8.4 Power conservation

The HygroVUE 10 draws less than 100  $\mu\text{A}$  (50  $\mu\text{A}$  typical) of current between measurements. In most applications this is insignificant compared to the data logger and other power draws, so the sensor can be permanently powered.

In very low-power applications, conserve battery power by turning the 12 V supply to the HygroVUE 10 on just before the measurement (allowing a warm-up time of at least 1.8 s) and then turning it off afterwards. If available, the switched 12 V output of the data logger can be used.

## 8.5 Measuring multiple SDI-12 sensors

Up to ten HygroVUE 10s or a combination of other SDI-12 sensors can be connected to a single data logger terminal. Each SDI-12 device must have a unique SDI-12 address between 0-9, A-Z, or a-z. See [Change address command \(aAb!\)](#) (p. 28) to change the HygroVUE 10 SDI-12 address from its default address of 0.

# 9. Troubleshooting and maintenance

---

**NOTE:**

All factory repairs and recalibrations require a returned material authorization (RMA) and completion of the “Statement of Product Cleanliness and Decontamination” form. Refer to the [Assistance](#) page at the end of this manual for more information.

## 9.1 Troubleshooting

Symptom	Possible cause	Solution
Temperature is reported as <b>–9999</b> or <b>NAN</b> , and relative humidity is reported as <b>0</b> or as an unchanging value.	This indicates a problem with the SDI-12 communications with the sensor.	<p>Recheck the sensor wiring.</p> <p>Check the voltage to the sensor is 12V with a digital voltage meter.</p> <p>Verify the sensor SDI-12 address matches the address entered for the <a href="#">SDI12Recorder()</a> instruction.</p>
Inaccurate temperature or relative humidity is reported.	<p>Inadequate delay after power-up (only applicable if using SW12)</p> <p>The sensor element has been contaminated</p> <p>Electrical interference</p>	<p>Verify the program is allowing a power-up time of at least 100 ms.</p> <p>Clean the sensor tip with distilled water or replace it.</p> <p>Check that the sensor is not installed too close to a radio transmitter or cell phone.</p>
Temperature and relative humidity read –99.999	This indicates a fault with the sensor element itself or communication between the sensor element and the electronics in the sensor body.	<p>Check the sensor element is properly plugged in, with the correct orientation.</p> <p>Check for water being present under the sensor element connector and that there is no corrosion of the sensor pins or the socket.</p> <p>Swap the element for another one.</p>

## 9.2 Maintenance

The HygroVUE 10 sensor requires minimal maintenance, but dust, debris, and salts on the filter cap will degrade sensor performance. Check the white filter on the end of the sensor for debris. If dirt or salt is ingrained in the filter, clean with distilled water or replace it. Make sure the filter is screwed onto the sensor firmly with your fingers—do not over tighten.

Check the radiation shield monthly to make sure it is free from dust and debris. To clean the shield, first remove the sensor. Dismount the shield. Brush all loose dirt off. If more effort is

needed, use warm, soapy water and a soft cloth or brush to thoroughly clean the shield. Allow the shield to dry before remounting.

**NOTE:**

The HygroVUE 10 sensor body is sealed and filled with a potting compound to totally protect the electronics from any water ingress. This means there are no serviceable parts within the sensor body.

## 9.3 Calibration

The life of the sensor element is primarily limited by drift of the humidity sensor and your own acceptance of the errors incurred. Typical drift is less than 1% per year when used in cleaner environments but can be higher than this in polluted air. Because it can be difficult to know what the sensor has been exposed to and because the element is relatively inexpensive, Campbell Scientific recommends replacing the sensor element annually. Replacing the element effectively brings the sensor back to a factory calibration state both for temperature and relative humidity.

If you wish to check an old element's calibration you can measure its performance by plugging it into another sensor body in your calibration laboratory.

**NOTE:**

We cannot guarantee the accuracy of measurements if the sensor element is not changed every year.

## 9.4 Sensor element replacement

The replacement sensor element has a single row of 4 pins which mates into one side of an eight-way socket at the end of the probe. The element can be mounted into either side of the connector but the orientation of the sensor in relation to the pins is critical. Please refer to [FIGURE 9-1](#) (p. 19).

Please note that these elements are NOT available off the shelf from any other supplier than Campbell Scientific as the small circuit boards are specially coated to ensure longer life at high humidity.

To replace the element:

1. Wash your hands to avoid getting dirt or grease on the element. If possible use cotton gloves and handle the element by the edges of the small circuit board. Avoid touching the square white filter on the surface of the small, black component on top of the circuit board.

**NOTE:**

If dirt, salt or grease are left on the face of the sensor element during the process of handling the element, it may influence the measurements made.

2. Disconnect the sensor from the 12 V power supply.
3. Remove the filter by unscrewing it counter clockwise when looking towards the tip of the sensor.

**CAUTION:**

The filter cap unscrews from the sensor. Attempting to pull it off may damage it.

4. Identify the sensor element. The element plugs into the black plastic socket that protrudes by about 2 mm from the end of the body of the sensor.
5. Grasp the body of the sensor (this also ensures you are at the same electrical potential as the element) and, holding the edge of the circuit board between your fingertips, pull the element out of the socket. Store the old element in electrostatic protective packaging if you wish to retain it. (Please avoid pink colored electrostatic bags as they can emit chemicals which change the calibration of the sensor.)
6. With the element removed, check for dirt and/or corrosion around the socket. Clean any dirt away using a damp cloth to remove any salts that might be there.
7. Unpack the replacement element, avoiding static discharges to the element by making sure you touch the packaging before the element. The element can be inserted into either row of four holes in the socket, but it must be orientated so the sensing element with the white cover, is facing into the center line of the socket, towards the empty row of holes (see [FIGURE 9-1](#) (p. 19)).
8. Hold the element by the sides of the circuit board. Carefully match the pins to the socket in the end of sensor. Gently push the pins into the socket until they will not go in any further.
9. Before replacing the filter element and turning on power to the sensor, double-check that the element is seated correctly.

**CAUTION:**

If the element is not plugged into the socket correctly or there is contamination or excess water bridging the connections, it will not work. The element may draw excessive power from the supply and may be damaged if left powered in this state for more than a few seconds.

10. Screw the filter back onto the end of the sensor, making sure it clears the sensor element. If the element appears too close to the filter, there is a fair chance that it has been inserted in

the incorrect orientation or that the legs of the element have been bent. Screw the filter onto the thread and tighten gently with your fingers.

**CAUTION:**

Only tighten the filter approximately 1/8th of a turn by hand when the filter is fully screwed onto the thread. Over-tightening the filter will damage it and cause problems in inserting and removing the sensor from some shields.

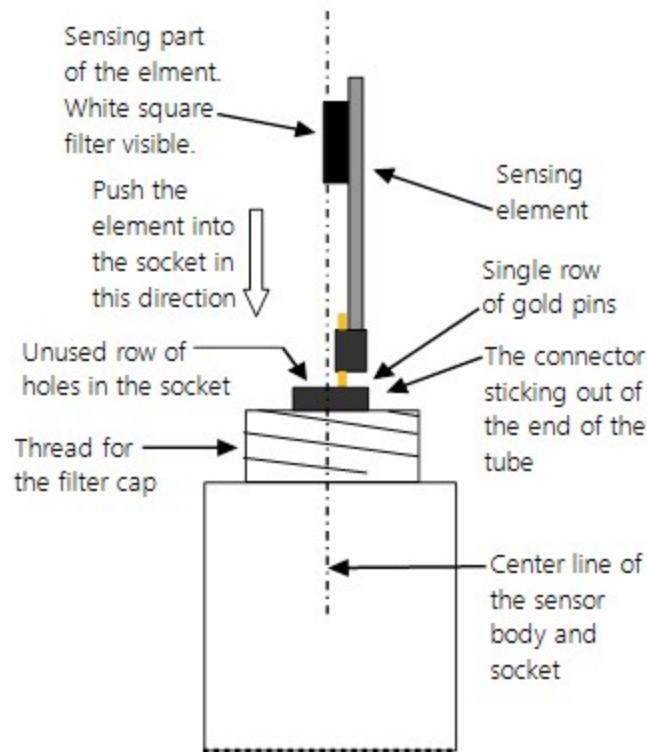

FIGURE 9-1. Correct fit of the 4-pin sensor element (side view)

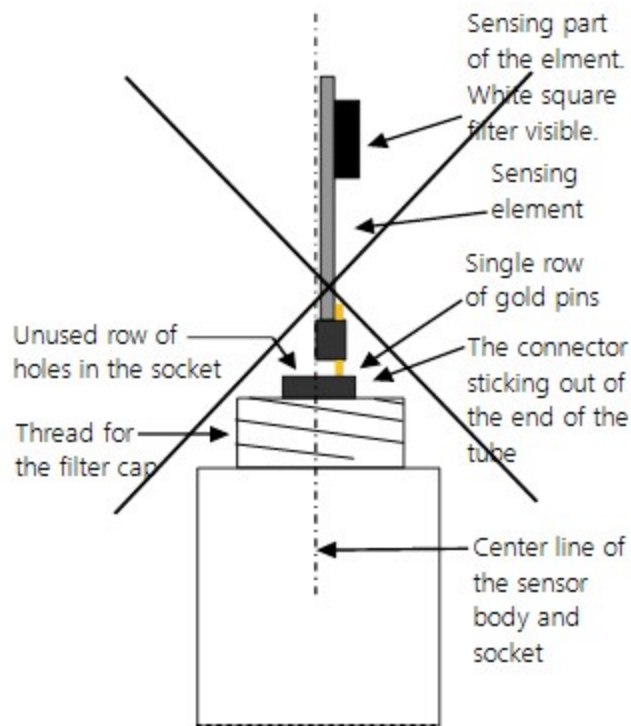

FIGURE 9-2. Incorrect fit of the 4-pin sensor element (side view)

## 10. Attributions and references

AASC, 1985: The State Climatologist (1985) Publication of the American Association of State Climatologists: *Heights and Exposure Standards for Sensors on Automated Weather Stations*, v. 9, No. 4 October, 1985. ([www.stateclimate.org/publications/state-climatologist/NOAA-NCY-SCBOOKS-SC77097/00000029.pdf](http://www.stateclimate.org/publications/state-climatologist/NOAA-NCY-SCBOOKS-SC77097/00000029.pdf))

Alduchov, O. A., and R. E. Eskridge, 1996: Improved Magnus form approximation of saturation vapour pressure. *J. Appl Meteor.*, 35, 601-609.

EPA, 2008: *Quality Assurance Handbook for Air Pollution Measurement Systems*, Vol. IV, Meteorological Measurements, Ver. 2.0, EPA-454/B-08-002 (revised 2008). Office of Air Quality Planning and Standards, Research Triangle Park, NC 27711.

Meyer, S. J. and K. G. Hubbard, 1992: Nonfederal Automated Weather Stations and Networks in the United States and Canada: A Preliminary Survey, *Bulletin Am. Meteor. Soc.*, 73, No. 4, 449-457.

WMO, 2008. *Guide to Meteorological Instruments and Methods of Observation*. World Meteorological Organization No. 8, 7th edition, Geneva, Switzerland.

# Appendix A. Importing *Short Cut* code into *CRBasic Editor*

---

*Short Cut* creates a .DEF file that contains wiring information and a program file that can be imported into the *CRBasic Editor*. By default, these files reside in the C:\campbellsci\SCWin folder.

Import *Short Cut* program file and wiring information into *CRBasic Editor*:

1. Create the *Short Cut* program. After saving the *Short Cut* program, click the **Advanced** tab then the **CRBasic Editor** button. A program file with a generic name will open in CRBasic. Provide a meaningful name and save the CRBasic program. This program can now be edited for additional refinement.

**NOTE:**

Once the file is edited with *CRBasic Editor*, *Short Cut* can no longer be used to edit the program it created.

2. To add the *Short Cut* wiring information into the new CRBasic program, open the .DEF file located in the C:\campbellsci\SCWin folder, and copy the wiring information, which is at the beginning of the .DEF file.
3. Go into the CRBasic program and paste the wiring information into it.
4. In the CRBasic program, highlight the wiring information, right-click, and select **Comment Block**. This adds an apostrophe (') to the beginning of each of the highlighted lines, which instructs the data logger compiler to ignore those lines when compiling. The **Comment Block** feature is demonstrated at about 5:10 in the [CRBasic | Features](#) video .



# Appendix B. CRBasic example program

This CR1000X program can be adapted for use with the CR6, CR3000, CR800-series, CR300-series, and CR1000 data loggers. For a CR200(X)-series program, see an older manual at [www.campbellsci.com/old-manuals](http://www.campbellsci.com/old-manuals).

## CRBasic Example 1: CR1000X program measuring the HygroVUE 10

*'Program measures one HygroVUE 10 sensor every 10 seconds and stores the average temperature and a sample of relative humidity every 10 minutes.*

*'Wiring Diagram*

*'=====*

*'HygroVUE 10*

*' Wire*

<i>' Color</i>	<i>' Function</i>	<i>' CR1000X</i>
----------------	-------------------	------------------

<i>' -----</i>	<i>' -----</i>	<i>' -----</i>
----------------	----------------	----------------

<i>' Brown</i>	<i>' Power (12V)</i>	<i>' Battery +</i>
----------------	----------------------	--------------------

<i>' White</i>	<i>' SDI-12 signal</i>	<i>' C1/SDI-12</i>
----------------	------------------------	--------------------

<i>' Black</i>	<i>' Power ground</i>	<i>' G</i>
----------------	-----------------------	------------

<i>' Clear</i>	<i>' Shield</i>	<i>' G</i>
----------------	-----------------	------------

*'Declare the variable array for the measurement*

```
Public TRHData(2)
```

```
Alias TRHData(1)=AirTC
```

```
Alias TRHData(2)=RH
```

```
Units AirTC=Deg C
```

```
Units RH=%
```

*'Define Data Tables*

```
DataTable(TenMin,True,-1)
```

```
  DataInterval(0,10,Min,10)
```

```
  Average(1,AirTC,FP2,False)
```

```
  Sample(1,RH,FP2)
```

```
EndTable
```

*'Main Program*

```
BeginProg
```

```
  Main Scan
```

## CRBasic Example 1: CR1000X program measuring the HygroVUE 10

```
Scan(10,Sec,1,0)  
  'HygroVUE 10 Temperature & Relative Humidity Sensor measurements 'AirTC'  
  'and 'RH'  
SDI12Recorder(TRHData(),C1,"0","M!",1,0)  
  'Call Data Tables and Store Data  
CallTable(TenMin)  
NextScan  
EndProg
```

# Appendix C. Environmental performance

---

This appendix details tests and limitations of the sensor when exposed to extremes of the environment.

## C.1 Exposure to pollutants

All capacitive sensors are susceptible to pollutants to some degree. The vapors may interfere with the polymer layers used in the structure of the sensing element. The diffusion of chemicals into the polymer may cause temporary or even permanent shifts in both offset and sensitivity. As a general rule, the sensor will not be damaged by levels of chemicals which are not too dangerous to human health, so damage is not normally a problem in outdoor applications.

However, exposure to volatile organic compounds at high concentrations and for long exposure times and exposure to acids or bases may be harmful, but there is less sensitivity if the  $\text{pH} < 9$ .

Corrosive substances at very low concentrations are not harmful to the sensor itself. However, they may attack the sensor contacts.

After low levels of exposure, in a clean environment most contaminants will slowly outgas and the sensor recovers.

If a sensor has been exposed to volatile organic compounds and is showing signs of drift it may be possible to recondition the sensors by heating the sensor to drive off the contaminants. Details of the procedure are given in [Operating range of the RH element](#) (p. 24).

## C.2 Operating range of the RH element

The RH sensor is specified to work over the entire humidity range of 0–100% RH for the temperature range  $-40$  to  $70$  °C. The sensor will perform best in the mid-range of humidity in the range of 20–80% RH.

In common with most types of unheated, polymeric humidity sensors the sensor can exhibit a temporary change in calibration, sometimes called long term hysteresis, when it is subjected to prolonged periods of high humidity and condensation. The sensor calibration may be temporarily altered, normally resulting in a change of less than +3% RH. The combination of high humidity and high temperature accelerates this change. However, upon returning to more

normal ambient conditions, the calibration will settle back to the normal calibration over the course of several hours or exceptionally a few days.

In laboratory conditions, it is possible to speed up the return to the normal calibration by reconditioning the element alone using this process:

1. Bake the sensor at 100–105 °C at < 5% RH for 10 hours.
2. Followed by re-hydration at 20–30 °C at ~ 75% RH for 12 hours.

The exact timing of these steps is not critical.

## C.3 Measurement below 0 °C

The chemistry of the HygroVUE 10 sensor element results in the sensor outputting a humidity reading that is referenced to the saturated water vapor pressure above liquid water, even at temperatures below 0 °C, where ice might form. This is the common way to express relative humidity and is as defined by the World Meteorological Organization. If an RH value is required to be referenced to ice, the HygroVUE 10 readings will need to be corrected. Please refer to standard text points on this matter for the correction required.

One consequence of using water as the reference is that the maximum humidity that will normally be output by the sensor for temperatures below freezing is as follows:

- 100% RH at 0 °C
- 95% RH at –5 °C
- 91% RH at –10 °C
- 87% RH at –15 °C
- 82% RH at –20 °C
- 78% RH at –25 °C
- 75% RH at –30 °C

In practical terms this means that, for instance, at –20 °C the air is effectively fully saturated above ice, and the sensor outputs 82% RH.

# Appendix D. SDI-12 sensor support

---

SDI-12, Serial Data Interface at 1200 baud, is a protocol developed to simplify sensor and data logger compatibility. Only three wires are necessary — serial data, ground, and 12 V. With unique addresses, multiple SDI-12 sensors can connect to a single SDI-12 terminal on a Campbell Scientific data logger.

This appendix discusses the structure of SDI-12 commands and the process of querying SDI-12 sensors. For more detailed information, refer to version 1.4 of the SDI-12 protocol, available at [www.sdi-12.org](http://www.sdi-12.org) .

For additional information, refer to the [SDI-12 Sensors | Transparent Mode](#) and [SDI-12 Sensors | Watch or Sniffer Mode](#) videos.

## D.1 SDI-12 command basics

SDI-12 commands have three components:

- **Sensor address (a)** – a single character and the first character of the command. Use the default address of zero (0) unless multiple sensors are connected to the same port.
- **Command body** – an upper case letter (the “command”), optionally followed by one or more alphanumeric qualifiers.
- **Command termination (!)** – an exclamation mark.

An active sensor responds to each command. Responses have several standard forms and always terminate with <CR> <LF> (carriage return and line feed). Standard SDI-12 commands are listed in [Table D-1](#) (p. 27).

**NOTE:**

The HygroVUE 10 does not support all variants of the commands in the following table.

**Table D-1: Campbell Scientific sensor SDI-12 command and response set**

Name	Command	Response <sup>1</sup>
Acknowledge Active	a!	a<CR><LF>
Send Identification	aI!	allccccccmmmmmmvvvxxx...xx <CR><LF>
Start Verification	aV!	atttn <CR><LF>
Address Query	?!	a<CR><LF>
Change Address	aAb!	b<CR><LF>
Start Measurement	aM! aM1! . . . aM9!	atttn<CR><LF>
Start Measurement and Request CRC	aMC! aMC1! . . . aMC9!	atttn <CR><LF>
Start Concurrent Measurement	aC! aC1! . . . aC9!	atttn<CR><LF>
Start Concurrent Measurement and Request CRC	aCC! aCC1! . . . aCC9!	atttn<CR><LF>
Send Data	aD0! . . . aD9!	a<values><CR><LF> or a<values><CRC><CR><LF>
Continuous Measurement	aR0! . . . aR9!	a<values><CR><LF>
Continuous Measurement and Request CRC	aRC0! . . . aRC9!	a<values><CRC><CR><LF>
Extended Commands	aXNNN!	a<values><CR><LF>

<sup>1</sup> Information on each of these commands is given in the following sections.

## D.1.1 Acknowledge active command (a!)

The Acknowledge Active command (a!) is used to test a sensor on the SDI-12 bus. An active sensor responds with its address.

## D.1.2 Send identification command (aI!)

Sensor identifiers are requested by issuing command aI!. The reply is defined by the sensor manufacturer but usually includes the sensor address, SDI-12 version, manufacturer's name, and

sensor model information. Serial number or other sensor specific information may also be included.

<b>aI!</b>	allccccccmmmmmmvvvxxx...xx<CR> <LF>
<b>a</b>	Sensor SDI-12 address
<b>ll</b>	SDI-12 version number (indicates compatibility)
<b>ccccccc</b>	8-character vendor identification
<b>mmmmmm</b>	6 characters specifying the sensor model
<b>vvv</b>	3 characters specifying the sensor version (operating system)
<b>xxx...xx</b>	Up to 13 optional characters used for a serial number or other specific sensor information that is not relevant for operation of the data logger
<b>&lt;CR&gt; &lt;LF&gt;</b>	Terminates the response
Source: <i>SDI-12: A Serial-Digital Interface Standard for Microprocessor-Based Sensors</i> (see References).	

### D.1.3 Start verification command (aV!)

The response to a Start Verification command can include hardware diagnostics, but like the **aI!** command, the response is not standardized.

Command: **aV!**

Response: *atttn*<CR><LF>

*a* = sensor address

*ttt* = time, in seconds, until verification information is available

*n* = the number of values to be returned when one or more subsequent **D!** commands are issued

### D.1.4 Address query command (?!)

Command **?!** requests the address of the connected sensor. The sensor replies to the query with the address, *a*. This command should only be used with one sensor on the SDI-12 bus at a time.

### D.1.5 Change address command (aAb!)

Multiple SDI-12 sensors can connect to a single SDI-12 terminal on a data logger. Each device on a single terminal must have a unique address.

A sensor address is changed with command **aAb!**, where *a* is the current address and *b* is the new address. For example, to change an address from 0 to 2, the command is **0A2!**. The sensor responds with the new address *b*, which in this case is 2.

**NOTE:**

Only one sensor should be connected to a particular terminal at a time when changing addresses.

## D.1.6 Start measurement commands (aM!)

A measurement is initiated with the **M!** command. The response to each command has the form *attn*<CR><LF>, where

*a* = sensor address

*ttt* = time, in seconds, until measurement data is available. When the data is ready, the sensor notifies the data logger, and the data logger begins issuing **D** commands.

*n* = the number of values returned when one or more subsequent **D** commands are issued. For the **aM!** command, *n* is an integer from 0 to 9.

When the **aM!** is issued, the data logger pauses its operation and waits until either it receives the data from the sensor or the time, *ttt*, expires. Depending on the scan interval of the data logger program and the response time of the sensor, this may cause skipped scans to occur. In this case make sure your scan interval is longer than the longest measurement time (*ttt*).

Table D-2: Example aM! sequence	
<b>0M!</b>	The data logger makes a request to sensor 0 to start a measurement.
00352<CR><LF>	Sensor 0 immediately indicates that it will return two values within the next 35 seconds.
0<CR><LF>	Within 35 seconds, sensor 0 indicates that it has completed the measurement by sending a service request to the data logger.
<b>0D0!</b>	The data logger immediately issues the first <b>D</b> command to collect data from the sensor.
0+.859+3.54<CR><LF>	The sensor immediately responds with the sensor address and the two values.

## D.1.7 Start concurrent measurement commands (aC!)

A concurrent measurement (**aC!**) command follows the same pattern as the **aM!** command with the exception that it does not require the data logger to pause its operation, and other SDI-12



sensors may take measurements at the same time. The sensor will not issue a service request to notify the data logger that the measurement is complete. The data logger will issue the **aD0!** command during the next scan after the measurement time reported by the sensor has expired. To use this command, the scan interval should be 10 seconds or less. The response to each command has the form *atttn*<CR><LF>, where

*a* = the sensor address

*ttt* = time, in seconds, until the measurement data is available

*nn* = the number of values to be returned when one or more subsequent **D** commands are issued.

See the following example. A data logger has three sensors wired into terminal **C1**. The sensors are addresses X, Y, and Z. The data logger will issue the following commands and receive the following responses:

Table D-3: Example aC! sequence	
<b>XC!</b>	The data logger makes a request to sensor X to start a concurrent measurement.
X03005<CR><LF>	Sensor X immediately indicates that it will have 5 (05) values ready for collection within the next 30 (030) seconds.
<b>YC!</b>	The data logger makes a request to sensor Y to start a concurrent measurement.
Y04006<CR><LF>	Sensor Y immediately indicates that it will have 6 (06) values ready for collection within the next 40 (040) seconds.
<b>ZC!</b>	The data logger makes a request to sensor Z to start a concurrent measurement.
Z02010<CR><LF>	Sensor Z immediately indicates that it will have 10 values ready for collection within the next 20 (020) seconds.
<b>ZD0!</b>	After 20 seconds have passed, the data logger starts the process of collecting the data by issuing the first <b>D</b> command to sensor Z.
Z+1+2+3+4+5+6+7+8+9+10<CR><LF>	Sensor Z immediately responds with the sensor address and the 10 values.

Table D-3: Example aC! sequence	
XD0!	10 seconds later, after a total of 30 seconds have passed, the data logger starts the process of collecting data from sensor X by issuing the first D command.
X+1+2+3+4+5<CR><LF>	The sensor immediately responds with the sensor address and the 5 values.
YD0!	Ten seconds later, after a total of 40 seconds have passed, the data logger starts the process of collecting data from sensor Y by issuing the first D command.
Y+1+2+3+4+5+6<CR><LF>	The sensor immediately responds with the sensor address and the 6 values.

## D.1.8 Start measurement commands with cyclic redundancy check (aMC! and aCC!)

Error checking is done by using measurement commands with cyclic redundancy checks (**aMC!** or **aCC!**). This is most commonly implemented when long cable lengths or electronic noise may impact measurement transmission to the data logger. When these commands are used, the data returned in response to **D** or **R** commands must have a cyclic redundancy check (CRC) code appended to it. The CRC code is a 16-bit value encoded within 3 characters appended before the <CR><LF>. This code is not returned in the data table but checked by the data logger as it comes. The code returned is based on the SDI-12 protocol. See the SDI-12 communication specification for version 1.4 available at [www.sdi-12.org](http://www.sdi-12.org) to learn more about how the CRC code is developed.

## D.1.9 Stopping a measurement command

A measurement command (**M!**) is stopped if it detects a break signal before the measurement is complete. A break signal is sent by the data logger before most commands.

A concurrent measurement command (**C!**) is aborted when another valid command is sent to the sensor before the measurement time has elapsed.

## D.1.10 Send data command (aD0! ... aD9!)

The Send Data command requests data from the sensor. It is issued automatically with every type of measurement command (**aM!**, **aMC!**, **aC!**, **aCC!**). When the measurement command is **aM!**

or **aMC!**, the data logger issues the **aD0!** command once a service request has been received from the sensor or the reported time has expired. When the data logger is issuing concurrent commands (**aC!** or **aCC!**), the Send Data command is issued after the required time has elapsed (no service request will be sent by the sensor). In transparent mode (see [SDI-12 transparent mode](#) (p. 32)), the user asserts this command to obtain data.

Depending on the type of data returned and the number of values a sensor returns, the data logger may need to issue **aD0!** up to **aD9!** to retrieve all data. A sensor may return up to 35 characters of data in response to a **D** command that follows an **M!** or **MC!** command. A sensor may return up to 75 characters of data in response to a **D** command that follows a **C!** or **CC!** command. Data values are separated by plus or minus signs.

Command: **aD0!** (**aD1!** ... **aD9!**)

Response: *a*<values><CR><LF> or *a*<values><CRC><CR><LF>

where:

*a* = the sensor address

<values> = values returned with a polarity sign (+ or –)

<CR><LF> = terminates the response

<CRC> = 16-bit CRC code appended if data was requested with **aMC!** or **aCC!**.

## D.1.11 Continuous measurement command (**aR0!** ... **aR9!**)

Sensors that are able to continuously monitor the phenomena to be measured can be read directly with the **R** commands (**R0!** ... **R9!**). The response to the **R** commands mirrors the Send Data command (**aD0!**). A maximum of 75 characters can be returned in the <values> part of the response to the **R** command.

## D.2 References

*SDI-12 Support Group. SDI-12: A Serial-Digital Interface Standard for Microprocessor-Based Sensors – Version 1.4.* River Heights, UT: SDI-12 Support Group, 2017. <https://sdi-12.org/specification> .

## D.3 SDI-12 transparent mode

System operators can manually interrogate and enter settings in probes using transparent mode. Transparent mode is useful in troubleshooting SDI-12 systems because it allows direct communication with probes. Data logger security may need to be unlocked before activating the transparent mode.

Transparent mode is entered while the computer is communicating with the data logger through a terminal emulator program. It is accessed through Campbell Scientific data logger support software or other terminal emulator programs. Data logger keyboards and displays cannot be used.

The terminal emulator is accessed by navigating to the **Tools** list in *PC400* or the **Datalogger** list in the **Connect** screen of *LoggerNet*.

Watch [videos/sdi12-sensors-transparent-mode](#)  from our website.

Data loggers from other manufacturers will also have a transparent mode. Refer to those manuals on how to use their transparent mode.

The following examples show how to enter transparent mode and change the SDI-12 address of an SDI-12 sensor. The steps shown in [Changing an SDI-12 address](#) (p. 33) are used with most Campbell Scientific data loggers.

## D.3.1 Changing an SDI-12 address

This example was done with a CR1000X, but the steps are only slightly different for CR6, CR3000, CR800-series, CR300-series, CR1000 data loggers.

1. Connect an SDI-12 sensor to the CR1000X.
2. Open *Device Configuration* utility.
3. Under **Device Type**, type the data logger model and double-click on the model type. This example uses a CR1000X directly connected to the computer USB port.

4. Select the correct **Communication Port** and click **Connect**.

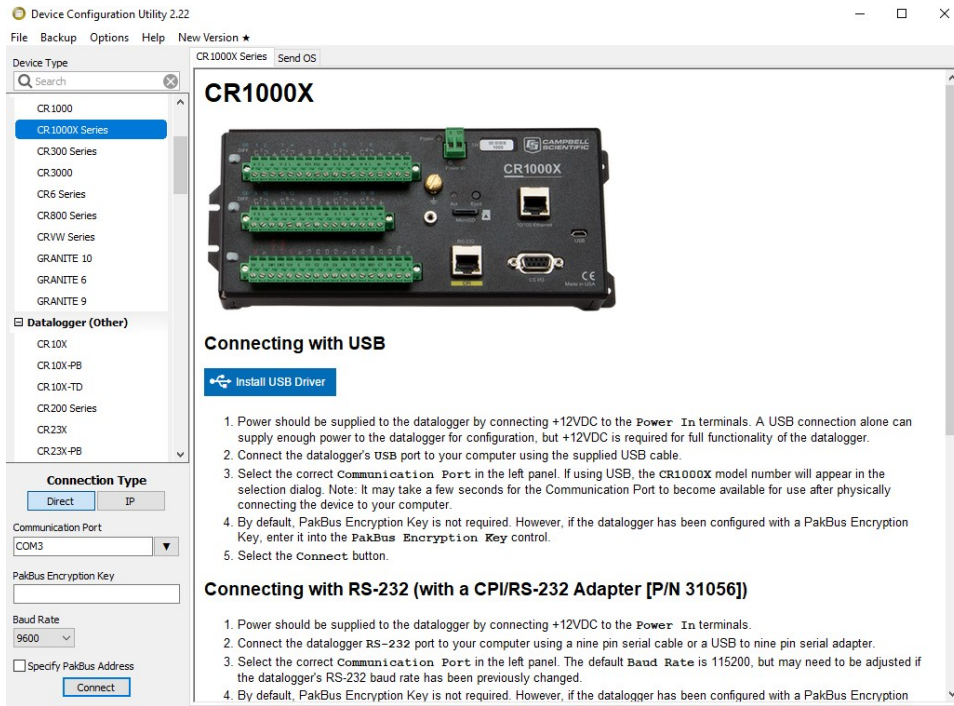

5. Click the **Terminal** tab.

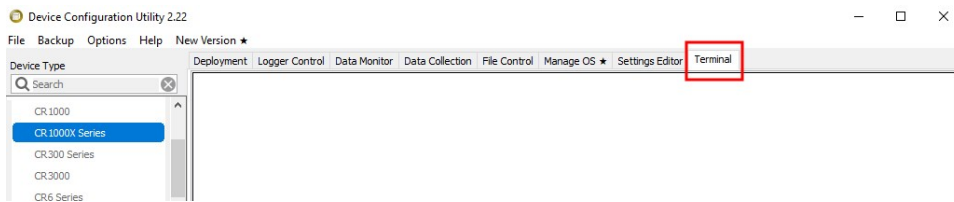

6. Select **All Caps Mode**.

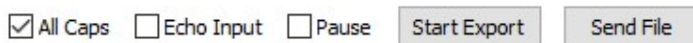

7. Press Enter until the data logger responds with the data logger (**CR1000X>**) prompt.

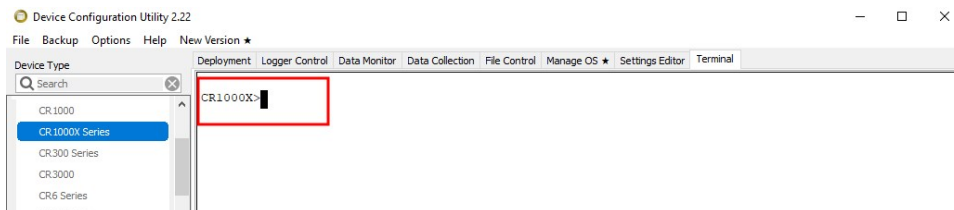

8. Type **SDI12** and press Enter.

9. At the **Select SDI12 Port** prompt, type the number corresponding to the control port where the sensor is connected and press Enter. In this example the sensor is connected to C3. The

response **Entering SDI12 Terminal** indicates that the sensor is ready to accept SDI-12 commands.

```
CR1000X>
CR1000X>SDI12
1: C1
2: C3
3: C5
4: C7
Select SDI12 Port: 2
```

10. To query the sensor for its current SDI-12 address, type **?!** and press Enter. The sensor responds with its SDI-12 address. If no characters are typed within 60 seconds, the mode is exited. In that case, simply type **SDI12** again, press Enter, and type the correct control port number when prompted.

```
?!
0
```

11. To change the SDI-12 address, type **aAb!**, where **a** is the current address from the previous step and **b** is the new address. Press **Enter**. The sensor changes its address and responds with the new address. In the following example, the sensor address is changed from 0 to B.

```
SDI12
SDI12>0AB!B
```

12. To exit SDI-12 transparent mode, click **Close Terminal**.

**NOTE:**

The transparent mode for the CR6, CR3000, CR800-series, CR300-series, and CR1000 data loggers is similar to that shown for the CR1000X.

# Appendix E. Sensor element calibration

The sensor elements are individually calibrated during manufacture. The manufacturer publishes a statement (see [FIGURE E-1](#) (p. 36)) as a description of and evidence of traceability of the calibration of the HygroVUE 10 sensor element.



Calibration Certification – Digital Humidity- and Temperature Sensors		<b>SENSIRION</b> THE SENSOR COMPANY	
<b>Calibration Certification</b>			
<b>Name and address of the manufacturer:</b>	Sensirion AG Laubisruetistrasse 50 CH-8712 Switzerland		
<b>Description:</b>	Digital Humidity- and Temperature Sensors		
	<ul style="list-style-type: none"><li>• SHT1x</li><li>• SHT3x</li><li>• SHTC1</li><li>• STS21</li></ul>	<ul style="list-style-type: none"><li>• SHT2x</li><li>• SHT7x</li><li>• SHTW2</li><li>• STS3x</li></ul>	
<p>The above mentioned products are calibrated to meet the specifications according to the corresponding Sensirion data sheet. Each device is individually tested after its calibration.</p> <p>Sensirion uses transfer standards for the calibration. These transfer standards are themselves subject to a scheduled calibration procedure. The calibration of the reference itself used for the calibration of the transfer standards is performed by an ISO/IEC 17025 accredited laboratory.</p> <p>The accreditation body is full member of the International Laboratory Accreditation Cooperation (<a href="http://www.ilac.org">www.ilac.org</a>). Calibration certificates issued by facilities accredited by a signatory to the ILAC Mutual Recognition Arrangement (MRA) are accepted by all signatories to the ILAC MRA.</p> <p>This provides traceability of measurement to recognized national standards and to units of measurement realized at the "National Physical Laboratory" (NPL) or other recognized national standards laboratories like "Physikalisch-Technische Bundesanstalt" (PTB) or "National Institute of Standards and Technology" (NIST).</p>			
Staefa, February 2018			
			
Stephan Weber, Director, Head of Quality Management, Sensirion AG	Volker Born Manager, Head of Quality Engineering, SensirionAG		

FIGURE E-1. Calibration certificate

# Limited warranty

---

Products manufactured by Campbell Scientific are warranted by Campbell Scientific to be free from defects in materials and workmanship under normal use and service for twelve months from the date of shipment unless otherwise specified on the corresponding product webpage. See Product Details on the Ordering Information pages at [www.campbellsci.com](http://www.campbellsci.com)<sup>↗</sup>. Other manufacturer's products, that are resold by Campbell Scientific, are warranted only to the limits extended by the original manufacturer.

Refer to [www.campbellsci.com/terms#warranty](http://www.campbellsci.com/terms#warranty)<sup>↗</sup> for more information.

**CAMPBELL SCIENTIFIC EXPRESSLY DISCLAIMS AND EXCLUDES ANY IMPLIED WARRANTIES OF MERCHANTABILITY OR FITNESS FOR A PARTICULAR PURPOSE.** Campbell Scientific hereby disclaims, to the fullest extent allowed by applicable law, any and all warranties and conditions with respect to the Products, whether express, implied or statutory, other than those expressly provided herein.



# Assistance

---

Products may not be returned without prior authorization.

Products shipped to Campbell Scientific require a Returned Materials Authorization (RMA) or Repair Reference number and must be clean and uncontaminated by harmful substances, such as hazardous materials, chemicals, insects, and pests. Please complete the required forms prior to shipping equipment.

Campbell Scientific regional offices handle repairs for customers within their territories. Please see the back page for the Global Sales and Support Network or visit [www.campbellsci.com/contact](http://www.campbellsci.com/contact)  to determine which Campbell Scientific office serves your country.

To obtain a Returned Materials Authorization or Repair Reference number, contact your CAMPBELL SCIENTIFIC regional office. Please write the issued number clearly on the outside of the shipping container and ship as directed.

For all returns, the customer must provide a "Statement of Product Cleanliness and Decontamination" or "Declaration of Hazardous Material and Decontamination" form and comply with the requirements specified in it. The form is available from your CAMPBELL SCIENTIFIC regional office. Campbell Scientific is unable to process any returns until we receive this statement. If the statement is not received within three days of product receipt or is incomplete, the product will be returned to the customer at the customer's expense. Campbell Scientific reserves the right to refuse service on products that were exposed to contaminants that may cause health or safety concerns for our employees.

# Safety

---

**DANGER** — MANY HAZARDS ARE ASSOCIATED WITH INSTALLING, USING, MAINTAINING, AND WORKING ON OR AROUND **TRIPODS, TOWERS, AND ANY ATTACHMENTS TO TRIPODS AND TOWERS SUCH AS SENSORS, CROSSARMS, ENCLOSURES, ANTENNAS, ETC.** FAILURE TO PROPERLY AND COMPLETELY ASSEMBLE, INSTALL, OPERATE, USE, AND MAINTAIN TRIPODS, TOWERS, AND ATTACHMENTS, AND FAILURE TO HEED WARNINGS, INCREASES THE RISK OF DEATH, ACCIDENT, SERIOUS INJURY, PROPERTY DAMAGE, AND PRODUCT FAILURE. TAKE ALL REASONABLE PRECAUTIONS TO AVOID THESE HAZARDS. CHECK WITH YOUR ORGANIZATION'S SAFETY COORDINATOR (OR POLICY) FOR PROCEDURES AND REQUIRED PROTECTIVE EQUIPMENT PRIOR TO PERFORMING ANY WORK.

Use tripods, towers, and attachments to tripods and towers only for purposes for which they are designed. Do not exceed design limits. Be familiar and comply with all instructions provided in product manuals. Manuals are available at [www.campbellsci.com](http://www.campbellsci.com). You are responsible for conformance with governing codes and regulations, including safety regulations, and the integrity and location of structures or land to which towers, tripods, and any attachments are attached. Installation sites should be evaluated and approved by a qualified engineer. If questions or concerns arise regarding installation, use, or maintenance of tripods, towers, attachments, or electrical connections, consult with a licensed and qualified engineer or electrician.

## General

- Protect from over-voltage.
- Protect electrical equipment from water.
- Protect from electrostatic discharge (ESD).
- Protect from lightning.
- Prior to performing site or installation work, obtain required approvals and permits. Comply with all governing structure-height regulations.
- Use only qualified personnel for installation, use, and maintenance of tripods and towers, and any attachments to tripods and towers. The use of licensed and qualified contractors is highly recommended.
- Read all applicable instructions carefully and understand procedures thoroughly before beginning work.
- Wear a **hardhat** and **eye protection**, and take **other appropriate safety precautions** while working on or around tripods and towers.
- **Do not climb** tripods or towers at any time, and prohibit climbing by other persons. Take reasonable precautions to secure tripod and tower sites from trespassers.
- Use only manufacturer recommended parts, materials, and tools.

## Utility and Electrical

- **You can be killed** or sustain serious bodily injury if the tripod, tower, or attachments you are installing, constructing, using, or maintaining, or a tool, stake, or anchor, come in **contact with overhead or underground utility lines**.
- Maintain a distance of at least one-and-one-half times structure height, 6 meters (20 feet), or the distance required by applicable law, **whichever is greater**, between overhead utility lines and the structure (tripod, tower, attachments, or tools).
- Prior to performing site or installation work, inform all utility companies and have all underground utilities marked.
- Comply with all electrical codes. Electrical equipment and related grounding devices should be installed by a licensed and qualified electrician.
- Only use power sources approved for use in the country of installation to power Campbell Scientific devices.

## Elevated Work and Weather

- Exercise extreme caution when performing elevated work.
- Use appropriate equipment and safety practices.
- During installation and maintenance, keep tower and tripod sites clear of un-trained or non-essential personnel. Take precautions to prevent elevated tools and objects from dropping.
- Do not perform any work in inclement weather, including wind, rain, snow, lightning, etc.

## Maintenance

- Periodically (at least yearly) check for wear and damage, including corrosion, stress cracks, frayed cables, loose cable clamps, cable tightness, etc. and take necessary corrective actions.
- Periodically (at least yearly) check electrical ground connections.

## Internal Battery

- Be aware of fire, explosion, and severe-burn hazards.
- Misuse or improper installation of the internal lithium battery can cause severe injury.
- Do not recharge, disassemble, heat above 100 °C (212 °F), solder directly to the cell, incinerate, or expose contents to water. Dispose of spent batteries properly.

WHILE EVERY ATTEMPT IS MADE TO EMBODY THE HIGHEST DEGREE OF SAFETY IN ALL CAMPBELL SCIENTIFIC PRODUCTS, THE CUSTOMER ASSUMES ALL RISK FROM ANY INJURY RESULTING FROM IMPROPER INSTALLATION, USE, OR MAINTENANCE OF TRIPODS, TOWERS, OR ATTACHMENTS TO TRIPODS AND TOWERS SUCH AS SENSORS, CROSSARMS, ENCLOSURES, ANTENNAS, ETC.



## Global Sales & Support Network

A worldwide network to help meet your needs



### Campbell Scientific Regional Offices

#### Australia

**Location:** Garbutt, QLD Australia  
**Phone:** 61.7.4401.7700  
**Email:** [info@campbellsci.com.au](mailto:info@campbellsci.com.au)  
**Website:** [www.campbellsci.com.au](http://www.campbellsci.com.au)

#### Brazil

**Location:** São Paulo, SP Brazil  
**Phone:** 11.3732.3399  
**Email:** [vendas@campbellsci.com.br](mailto:vendas@campbellsci.com.br)  
**Website:** [www.campbellsci.com.br](http://www.campbellsci.com.br)

#### Canada

**Location:** Edmonton, AB Canada  
**Phone:** 780.454.2505  
**Email:** [dataloggers@campbellsci.ca](mailto:dataloggers@campbellsci.ca)  
**Website:** [www.campbellsci.ca](http://www.campbellsci.ca)

#### China

**Location:** Beijing, P. R. China  
**Phone:** 86.10.6561.0080  
**Email:** [info@campbellsci.com.cn](mailto:info@campbellsci.com.cn)  
**Website:** [www.campbellsci.com.cn](http://www.campbellsci.com.cn)

#### Costa Rica

**Location:** San Pedro, Costa Rica  
**Phone:** 506.2280.1564  
**Email:** [info@campbellsci.com](mailto:info@campbellsci.com)  
**Website:** [www.campbellsci.com](http://www.campbellsci.com)

#### France

**Location:** Vincennes, France  
**Phone:** 0033.0.1.56.45.15.20  
**Email:** [info@campbellsci.fr](mailto:info@campbellsci.fr)  
**Website:** [www.campbellsci.fr](http://www.campbellsci.fr)

#### Germany

**Location:** Bremen, Germany  
**Phone:** 49.0.421.460974.0  
**Email:** [info@campbellsci.de](mailto:info@campbellsci.de)  
**Website:** [www.campbellsci.de](http://www.campbellsci.de)

#### India

**Location:** New Delhi, DL India  
**Phone:** 91.11.46500481.482  
**Email:** [info@campbellsci.in](mailto:info@campbellsci.in)  
**Website:** [www.campbellsci.in](http://www.campbellsci.in)

#### South Africa

**Location:** Stellenbosch, South Africa  
**Phone:** 27.21.8809960  
**Email:** [sales@campbellsci.co.za](mailto:sales@campbellsci.co.za)  
**Website:** [www.campbellsci.co.za](http://www.campbellsci.co.za)

#### Spain

**Location:** Barcelona, Spain  
**Phone:** 34.93.2323938  
**Email:** [info@campbellsci.es](mailto:info@campbellsci.es)  
**Website:** [www.campbellsci.es](http://www.campbellsci.es)

#### Thailand

**Location:** Bangkok, Thailand  
**Phone:** 66.2.719.3399  
**Email:** [info@campbellsci.asia](mailto:info@campbellsci.asia)  
**Website:** [www.campbellsci.asia](http://www.campbellsci.asia)

#### UK

**Location:** Shepshed, Loughborough, UK  
**Phone:** 44.0.1509.601141  
**Email:** [sales@campbellsci.co.uk](mailto:sales@campbellsci.co.uk)  
**Website:** [www.campbellsci.co.uk](http://www.campbellsci.co.uk)

#### USA

**Location:** Logan, UT USA  
**Phone:** 435.227.9120  
**Email:** [info@campbellsci.com](mailto:info@campbellsci.com)  
**Website:** [www.campbellsci.com](http://www.campbellsci.com)