

HRXL-MaxSonar® - WR™ Series

High Resolution, Precision, IP67 Weather Resistant, Ultrasonic Range Finder

MB7360, MB7363, MB7366, MB7367, MB7368, MB7369, MB7375
 MB7380, MB7383, MB7386, MB7387, MB7388, MB7389, MB7395⁸



The HRXL-MaxSonar-WR sensor line is a cost-effective solution for applications requiring precision range-finding, low-voltage operation, space saving, low-cost, and IP67 rating for weather resistance.

The HRXL-MaxSonar-WR sensor line provides high accuracy and high resolution ultrasonic proximity detection and ranging in air. This sensor line features 1-mm resolution, target-size and operating-voltage compensation for improved accuracy, superior rejection of outside noise sources, internal speed-of-sound temperature compensation and optional external speed-of-sound temperature compensation. The HRXL-MaxSonar-WR/WRC models are available in 1.5-meter, 5-meter, or 10-meter models. This ultrasonic sensor detects objects from 1-mm and ranges to objects from 30-cm* to maximum range. Objects closer than 30-cm* are typically reported as 30-cm*. The interface output formats are pulse width, analog voltage, and digital serial in either RS232 (MB736X/MB7375) or TTL (MB738X/MB7395). Factory calibration is standard. *For select sensors this distance is 50-cm, refer to page 7.

<p>Precision Ultrasonic Range Sensing</p> <ul style="list-style-type: none"> • Range-finding at a fraction of the cost of other precision rangefinders • Reading-to-reading stability of 1-mm at 1-meter is typical¹ • Accuracy is factory-matched providing a typical accuracy of +/- 1% or better^{1,2} • Internal temperature compensation is standard and optional external temperature compensation • Determines range to largest object (MB7368, MB7369, MB7388, MB7389) • Determines range to first detectable object (MB7360, MB7363, MB7366, MB7367, MB7375, MB7380, MB7383, MB7386, MB7387, MB7395) • Excellent clutter rejection • Additional chemical resistance available⁶ 	<p>Very Low Power Requirements</p> <ul style="list-style-type: none"> • Fast first reading after power-up eases battery requirements • Wide, low supply voltage of 2.7V⁹ to 5.5V requirements eases battery powered design • Low current draw reduces current drain for battery operation • Very low-power rangefinder, excellent for multiple sensor or battery based systems <p>Easy to Use Component Module</p> <ul style="list-style-type: none"> • Gracefully handles other ultrasonic sensors⁵ • Stable and reliable range readings and excellent noise rejection make the sensor easy to use for most users • Easy to use interface with distance provided in a variety of outputs • Target size compensation provides greater consistency and accuracy • Sensor automatically handles acoustic noise^{2,4} • Calibrated sensor eliminates most sensor to sensor variations 	<p>Applications & Uses</p> <ul style="list-style-type: none"> • Tank level measurement (MB7369 or MB7389) • Weather station monitoring • Bin level measurement • Proximity zone detection • People detection • Robot ranging sensor • Long range object detection • Environments with acoustic and electrical noise • Height monitors • Auto sizing • Box dimensions • Automated factory systems <p>Notes:</p> <p>¹ Refer to section that compares WR to alternative housings on page 4</p> <p>² Users are encouraged to evaluate the sensor performance in their application</p> <p>³ Reference pages 10-11 for part specific timing information</p> <p>⁴ By design</p> <p>⁵ See page 7 for multi-sensor operation</p> <p>⁶ F-Option provides additional protection from hazardous chemical environments</p> <p>⁷ Please reference page 12 & 13 for minimum operating voltage verses temperature information</p> <p>⁸ Please reference page 25 for part number key</p> <p>⁹ Operation below 5V may cause reduced performance in some stated specifications</p>
--	--	--

Close Range Operation

Applications requiring 100% reading-to-reading reliability should not use MaxSonar sensors at a distance closer than 50-cm. Although most users find MaxSonar sensors to work reliably from 0 to 50-cm for detecting objects in many applications, MaxBotix® Inc. does not guarantee operational reliability for objects closer than the minimum reported distance. Because of ultrasonic physics, these sensors are unable to achieve 100% reliability at close distances.

Warning: Personal Safety Applications

We do not recommend or endorse this product be used as a component in any personal safety applications. This product is not designed, intended or authorized for such use. These sensors and controls do not include the self-checking redundant circuitry needed for such use. Such unauthorized use may create a failure of the MaxBotix® Inc. product which may result in personal injury or death. MaxBotix® Inc. will not be held liable for unauthorized use of this component.

General Characteristics

- Low cost ultrasonic rangefinder
- Detection out to 1.5-meters, 5-meters, or 10-meters
- Resolution of 1-mm
- Distance sensor from 50-cm to 1.5-meters, 30-cm to 5-meters, or 50-cm to 10-meters based on model
- Excellent ² Mean Time Between Failure (MTBF)

- Triggered operation yields real-time range data
- Free run operation with superior noise rejection ³
- Operating temperature range from -40°C to +65°C ⁷
- Operating voltage of 2.7V to 5.5V⁷
- Nominal current draw of 2.3mA (peak ~49mA) at 3.3V, and 3.1mA (peak ~98mA) at 5V
- IP67 Rated

Range Outputs

- Pulse width, 1uS/mm resolution
- Analog Voltage, 5-mm resolution (5-meter sensors)
- Analog Voltage, 10-mm resolution (1.5 and 10-meter sensors)
- Serial, 1-mm resolution
- Available in RS232 (MB736X and MB7375) or TTL (MB738X and MB7395)

HRXL-MaxSonar-WR Pin Out

Pin 1- Temperature Sensor Connection: Leave this pin unconnected if an external temperature sensor is not used. For best accuracy, this pin is optionally connected to the HR-MaxTemp temperature sensor. Some additional information for the temperature sensor can be found on page 12 of the datasheet.

Pin 2- Pulse Width Output: This pin outputs a pulse width representation of the distance with a scale factor of 1uS per mm. The pulse width output is sent with a value typically within +/- 1% of the serial output.

Pin 3- Analog Voltage Output: This pin outputs a single ended analog voltage scaled representation of the distance. This output is referenced to the sensor ground and Vcc. After the ~50mS power up initialization, the voltage on this pin is set to a low voltage. Once the sensor has completed a range reading the voltage on this pin is set to the voltage corresponding to the latest measured distance.

The 5-meter sensors (MB7360, MB7369, MB7380 and MB7389) use a scale factor of (Vcc/5120) per 1-mm. The distance is output with a 5-mm resolution. The analog voltage output is typically within ±10-mm of the serial output.

The 1.5-meter sensors (MB7375 and MB7395) and 10-meter sensors (MB7363, MB7366, MB7368, MB7383, MB7386, and MB7388) use a scale factor of (Vcc/10240) per 1-mm. The distance is output with a 10-mm resolution. The analog voltage output is typically within ±20-mm of the serial output.

Using a 10-bit analog to digital converter with the 5-meter sensors, one can read the analog voltage counts (i.e. 0 to 1023) directly and just multiply the number of counts in the value by 5 to yield the range in mm. For example, a converted value of 60 corresponds to 300-mm (where 60 x 5 = 300), and 1000 counts corresponds to 5,000-mm (where 1000 x 5 = 5,000-mm).

Using a 10-bit analog to digital converter with the 10-meter sensors, one can read the analog voltage counts (i.e. 0 to 1023) directly and just multiply the number of counts in the value by 10 to yield the range in mm. For example, 30 counts corresponds to 300-mm (where 30 x 10 = 300), and 1000 counts corresponds to 10,000-mm (where 1000 x 10 = 10,000-mm).

Pin 4- Ranging Start/Stop: This pin is internally pulled high. If this pin is left unconnected or held high, the sensor will continually measure and output the range data. If held low, the HRXL-MaxSonar-WR will stop ranging. Bring high for 20uS or longer to command a range reading.

Filtered Range Data: When pin 4 is left high on the sensors, the sensors will continue to range. The data that is output includes a filter for increased accuracy. The sensors will output the range based on recent range information. The filter does not affect the speed at which data is made available to the user but instead allows for more consistent range information to be presented. For sensor specific timing and filter information refer to pages 10 and 11.

Real-time Range Data: When pin 4 is low and then brought high, the sensor will operate in real time and the first reading output will be the range measured from this first commanded range reading. When the sensor tracks that the RX pin is low after each range reading, and then the RX pin is brought high, unfiltered real time range information can be obtained. For timing information please refer to pages 10 and 11.

Pin 5-Serial Output: The MB736X/MB7375 sensors have an RS232 data format (with 0V to Vcc levels) and the MB738X/MB7395 sensors have a TTL outputs. The output is an ASCII capital “R”, followed by four ASCII character digits representing the range in millimeters, followed by a carriage return (ASCII 13). The maximum range reported is 4999 mm (5-meter models) or 9998 mm (10-meter models). A range value of 5000 or 9999 corresponds to no target being detected in the field of view.

The serial data format is 9600 baud, 8 data bits, no parity, with one stop bit (9600-8-N-1).

Because the data is presented in a binary data format, the serial output is most accurate .

On power up the sensor will send serial data about the sensor. [View an example here.](#)

V+ Pin 6 - Positive Power, Vcc: The sensor operates on voltages from 2.7V - 5.5V DC. For best operation, the sensor requires that the DC power be free from electrical noise. (For installations with known dirty electrical power, a 100uF capacitor and 10ohm resistor placed at the sensor pins between V+ and GND will typically correct the electrical noise.) Please reference page 12 & 13 for minimum operating voltage verses temperature information.

GND Pin 7 – Sensor ground pin: DC return, and circuit common ground.

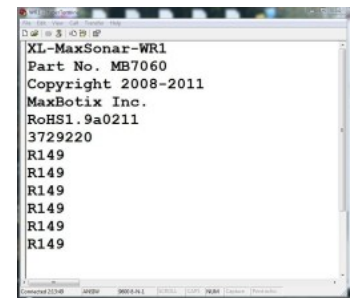

About Ultrasonic Sensors

The HRXL-MaxSonar-WR ultrasonic sensors are in-air, non-contact object detection and ranging sensors that detect objects within an area. These sensors are not affected by the color or other visual characteristics of the detected object. Ultrasonic sensors use high frequency sound to detect and localize objects in a variety of environments. Ultrasonic sensors measure the time of flight for sound that has been transmitted to and reflected back from nearby objects. Based upon the time of flight, the sensor outputs a range reading.

Device Comparison

Part Number	Serial Interface	First Detectable target	Most Likely Filter ¹	High Performance HR Filter ²	Optimized for snow depth	Alternative Packages available	Soft/Small Target Detection ³	1.5 Meter Range	5 Meter Range	10 Meter Range
MB7360	RS232	Yes		Yes		Yes			Yes	
MB7363	RS232	Yes		Yes			Yes			Yes
MB7366	RS232	Yes		Yes						Yes
MB7368	RS232		Yes	Yes						Yes
MB7369	RS232		Yes	Yes		Yes			Yes	
MB7375	RS232	Yes		Yes		Yes		Yes		
MB7380	TTL	Yes		Yes		Yes			Yes	
MB7383	TTL	Yes		Yes			Yes			Yes
MB7386	TTL	Yes		Yes						Yes
MB7388	TTL		Yes	Yes						Yes
MB7389	TTL		Yes	Yes		Yes			Yes	
MB7395	TTL	Yes		Yes				Yes		

Notes

¹ Our standard sensors provide the range to the first target they detect. Our most-likely filter allows our sensors to continue looking for larger targets. This way they only give you the range to the target with the largest return of sound as seen by the sensor. Note that while this will often be the largest target in an environment, there are times when small targets will reflect more sound to the sensor than larger targets .

² Exceeds the ability of the first generation XL-MaxSonar-WR models MB70###. Also includes target size compensation, internal temperature sensor, external temperature sensor, factory calibration, supply voltage drop compensation, continuous automatic calibration, and side lobe suppression.

³ Higher gain and other calibration allows better performance to soft targets.

Auto Calibration

Each time a HRXL-MaxSonar-WR sensor takes a range reading, it calibrates itself. The sensor uses this data to range objects. If the temperature, humidity, or applied voltage changes during operation, the sensor will continue to function normally over the rated temperature range while applying compensation for changes caused by temperature and voltage.

Target Size Compensation

Most low cost ultrasonic rangefinders will report the range to smaller size targets as farther than the actual distance. In addition, they may also report the range to larger size targets as closer than the actual distance.

The HRXL-MaxSonar-WR sensor line compensates for target size differences. This means that, provided an object is large enough to be detected, the sensor will report the same distance, typically within +/- 1%¹, regardless of target size¹. Smaller targets can have additional detection noise that may limit this feature. In addition, targets with small or rounded surfaces may have an apparent distance that is slightly farther, where the distance reported may be a composite of the sensed object(s). Compensation for target size is applied to all range outputs: pulse width, analog voltage, and serial format output by the sensor.

Supply Voltage Compensation

During power up, the HRXL-MaxSonar-WR sensor line will calibrate itself for changes in supply voltage. Additionally, the sensor will compensate if the supplied voltage gradually changes.

If the average voltage applied to the sensor changes faster than 0.5V per second, it is best to remove and reapply power to the sensor.

For best operation, the sensor requires noise free power . If the sensor is used with noise on the supplied power or ground, the readings may be affected. Typically adding a 100uF capacitor and 10ohm resistor at the sensor between the V+ and GND pins will correct most power related electrical noise issues.

Notes: ¹ Refer to section that compares WR to WRC on page 4

Base sensor (MB7360 and MB7380)

The MB7360 and MB7380 are the base model of the HRXL-MaxSonar-WR sensor line. These sensors are recommended for users unsure of which sensor to use in their application. All other sensors in this series are based off of these sensor models. The additional features are mentioned in their respective sections below.

HRXL-MaxSonar-WRLS (MB7363 and MB7383)

The HRXL-MaxSonar-WRLS sensors are 10 meter sensors with a higher sensitivity than other HRXL-MaxSonar-WR products. This sensor is recommended for applications in which objects do not reflect enough ultrasonic sound, such as people, to be detected. Users are encouraged to test the sensor in their application to verify usability.

HRXL-MaxSonar-WRL (MB7366, MB7386)

The HRXL-MaxSonar-WRL sensors are the 10-meter version of the HRXL-MaxSonar-WR sensors.

HRXL-MaxSonar-WRML (MB7368, MB7388)

The HRXL-MaxSonar-WRML sensors are equipped with filtering firmware which allows the sensor to ignore smaller targets and noise, and still report the target that gives the largest acoustic return with a 10-meter maximum range. (The sensor will also reject periodic noise, even noise that has a higher amplitude than the acoustic return from the target.) This provides the flexibility to consistently range larger targets in the presence of clutter and noise. If the largest target is removed, the HRXL-MaxSonar-WRML will switch to the target with the next largest detectable return.

The HRXL-MaxSonar-WRML sensors were designed for applications where users were concerned with ranging the distance to large flat targets (such as in a water tank). This stands in contrast to other HRXL-MaxSonar-WR sensors which will report the distance to the first detectable target.

In general, the HRXL-MaxSonar-WRML will select the largest target from its field of view and report its range. Even so, objects up close may provide significantly greater returns over distant objects. Users are encouraged to test the sensor in their application to verify usability.

When targets are of similar amplitude reflections, preference is given to the closest target.

HRXL-MaxSonar-WRM (MB7369 and MB7389)

The HRXL-MaxSonar-WRM sensors are the 5-meter version of the HRXL-MaxSonar-WRML sensors.

HRXL-MaxSonar-WRB (MB7375 and MB7395)

The HRXL-MaxSonar-WRB sensors are the 1.525-meter (5-foot) wide beam versions of HRXL-MaxSonar-WRML sensors.

About Package Types

The HRXL-MaxSonar-WR sensors are available in a variety of packages for applications with specific mounting requirements. The full horn package provides peak accuracy and sensitivity in this sensor line. It is recommended that testing is completed to ensure that the selected sensor will operate as desired in your application.

Package Types Currently Available
Full Horn – 3/4” NPT straight; back mounted thread
Compact – 3/4” NPT straight; back mounted thread
1”NPS – External thread over full sensor body (1”NPS)
1”BSPP – External thread over full sensor body (1”BSPP)
30mm1.5 – External thread over full sensor body (30mm1.5)
Extended Horn – 3/4” NPT straight; back mounted thread. Enhanced detection of distant and small targets.
All package types have exposed PCB on user end for easy connection. Users desiring a fully enclosed assembly may purchase the “Shielded Cable Attach Option” along with their sensor.



Performance Changes when Selecting a Non-Full Horn Package

When selecting a HRXL-MaxSonar-WR sensor without the full horn the sensor will experience the following performance changes:

- The sensor will have a wider beam shape for the first meter.
- The sensor may be less accurate by an additional +/- 0.5%.
- The sensor may have a dead zone from 0mm–500mm.
- The sensor may have worse performance to small or soft targets.
- The sensor may experience decreased noise immunity when ranging to small, soft, angled, or distant targets.

Mechanical Dimensions

Full Horn

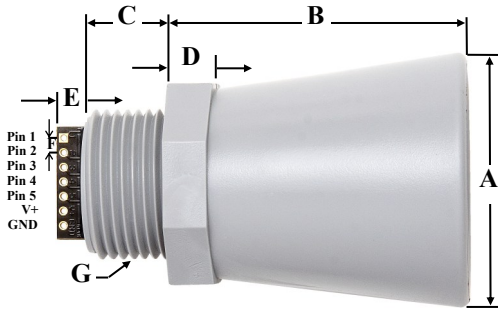

A	1.72" dia.	43.8 mm dia.
B	2.00"	50.7 mm
C	0.58"	14.4 mm
D	0.31"	7.9 mm
E	0.23"	5.8 mm
F	0.1"	2.54 mm
G	3/4"-14 NPS	
H	1.032" dia.	26.2 mm dia.
I	1.37"	34.8 mm
Weight, 1.76 oz., 50 grams		

Values Are Nominal

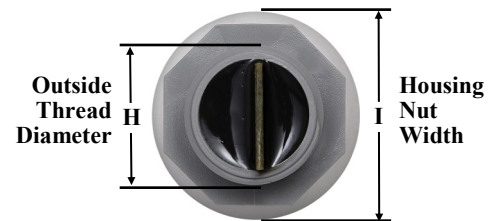

Compact Housing

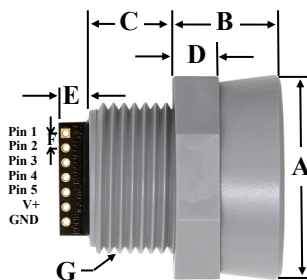

A	1.37" dia.	34.7 mm dia.
B	0.70"	17.9 mm
C	0.57"	14.4 mm
D	0.31"	7.9 mm
E	0.23"	5.8 mm
F	0.1"	2.54 mm
G	3/4"-14 NPS	
H	1.032" dia.	26.2 mm dia.
I	1.37"	34.8 mm
Weight, 1.23 oz., 32 grams		

Values Are Nominal

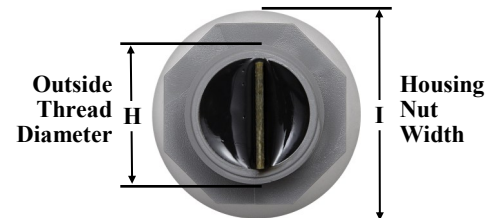

1" NPS Pipe Threading

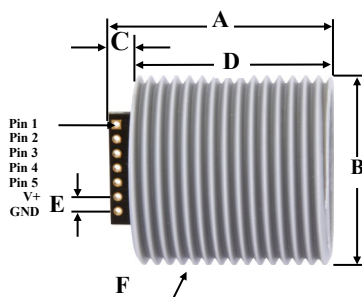

A	1.52"	38.5 mm
B	1.29" dia.	33.0 mm dia.
C	0.22"	5.5 mm
D	1.30"	33.1 mm
E	0.10"	2.54 mm
F	1" - NPS	
G	0.78"	19.81 mm
Weight, 1.23 oz., 35 grams		

Values Are Nominal

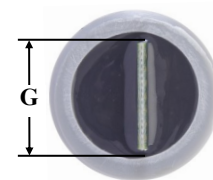

Mechanical Dimensions Continued

1" BSPP Pipe Threading

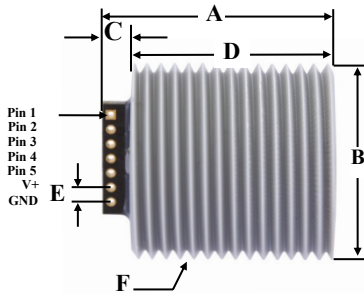

A	1.31"	33.3 mm
B	1.29" dia.	33.0 mm dia.
C	0.22"	5.5 mm
D	1.30"	33.1 mm
E	0.10"	2.54 mm
F	1" — BSPP	
G	0.78"	19.81 mm
Weight, 1.21 oz., 34.3 grams		

Values Are Nominal

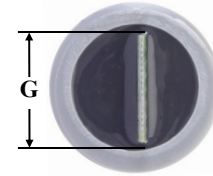

30mm1.5 Pipe Threading

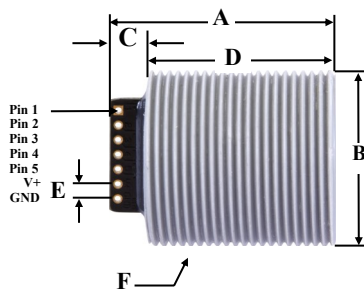

A	1.52"	38.5 mm
B	1.17" dia.	29.7 mm dia.
C	0.22"	5.5 mm
D	1.30"	33.1 mm
E	0.10"	2.54 mm
F	30mm 1.5	
G	0.78"	19.81 mm
Weight, 1.10 oz., 31.1 grams		

Values Are Nominal

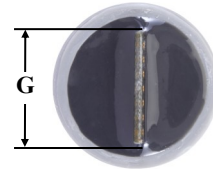

Extended Horn

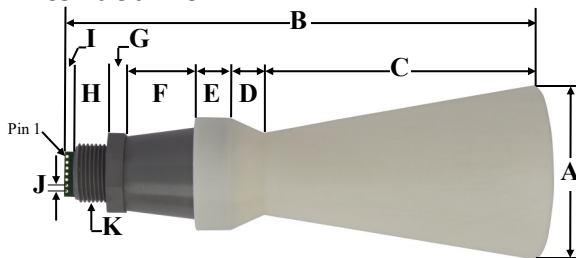

A	3.00" dia.	76.2 mm dia.
B	8.25"	209.6mm
C	4.827"	122.6mm
D	0.636"	16.2mm
E	0.580"	14.7mm

F	1.198"	30.4mm
G	0.31"	7.9mm
H	0.58"	14.7mm
I	0.23"	5.8mm
J	0.10"	2.54 mm

Values Are Nominal

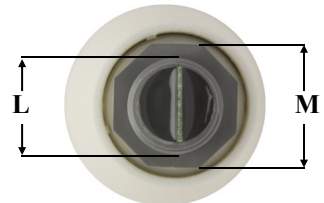

K	3/4"-14 NPS	
L	1.03" dia.	26.2 mm dia.
M	1.37"	34.8 mm
Weight		50 grams

Operating Modes

Free-Run Operation

When operating in free run mode, the HRXL-MaxSonar-WR sensors are designed to be used in a variety of outdoor, industrial, or indoor situations. Many acoustic noise sources will have little to no effect on the reported range of the HRXL-MaxSonar-WR sensors. Most range readings are accurately reported. If the range readings are affected, the effect is typically less than 5-mm¹. This allows users to employ real-time ultrasonic distance sensing without the need for additional supporting circuitry or complicated user software.

Multiple HRXL-MaxSonar-WR sensors can be operated in the same general locations. The internal noise filter is able to filter out the ultrasonic noise from other HRXL-MaxSonar-WR sensors with minimal interference. Typically, when operating with multiple sensors, the range readings will be within ±1 cm of the actual range to the intended target.

Notes: ¹ Refer to section that compares WR to WRC on page 4

HRXL-MaxSonar-WR Exposed Materials

The exposed materials of a properly mounted HRXL-MaxSonar-WR standard sensor are: Aluminum (oxidized surface), PVC, & silicone rubber (VMQ).

While most of our housings are made of PVC, our -8xx style extended horn products are made of ABS plastic. ABS is not compatible for use with gasoline. Direct contact will cause weakening and deformation of the horns. Extended exposure to vapors rising from gasoline may also damage these ABS housings.

Additional Options for Purchase

Please contact MaxBotix for any additional information regarding the options listed below at info@maxbotix.com

F-Option

In addition to the standard HRXL-MaxSonar-WR, MaxBotix Inc. has developed the F-Option for additional protection necessary in a few hazardous chemical environments. Extremely corrosive gases or liquids can degrade or compromise the operation of the sensing unit. As a result, we offer a more chemically inert seal which allows our sensors to operate in all but the harshest of chemical environments. In addition to the chemical resistance the sensor has improved performance in wet or dust environments.

Please Note: Our sensors are designed for operation in normal atmosphere (air). Please be aware that the speed of sound and atmospheric attenuation may change as a result of the transmission properties of different chemical/air mediums. Users are strongly encouraged to characterize and test the operation of the sensor in the new medium to verify operation, and properly scale the outputted range information.

The exposed materials of a properly mounted HRXL-MaxSonar-WR sensor with the F-Option added are: Aluminum (oxidized surface), PVC, & Fluorosilicone (with an additional back up FEP Teflon® seal¹).

Shielded Cable Attach Option

For simple integration of our sensors into end-user applications, MaxBotix has developed the Shielded Cable Attach option to create a completely IP67 rated MaxSonar-WR sensor. The standard Shielded Cable Attach Option uses 3 feet of the MaxSonar MB7954 Shielded Cable (MB7984 when attached by MaxBotix) with an epoxy filled cap to fully protect the pin-out of the MaxSonar sensor. Additional cable length can be specified and purchased using part number MB7984.

P-Option

The P-Option is a Parylene coating applied to the surface of the aluminum transducer. This helps to improve the corrosion resistance of the aluminum transducer. The exposed materials of a properly mounted HRXL-MaxSonar-WR sensor with the P-Option added are: Parylene, PVC, & silicone rubber (VMQ). The F-Option can be purchased with the P-Option.

Independent Sensor Operation

The HRXL-MaxSonar-WR sensors have the capability to operate independently when the user desires. When using the HRXL-MaxSonar-WR sensors in single or independent sensor operation, it is easiest to allow the sensor to free-run. Free-run is the default mode of operation for all of the MaxBotix Inc., sensors. The HRXL-MaxSonar-WR sensors have three separate outputs that update the range data simultaneously: Analog Voltage, Pulse Width, and Serial Data. Below are diagrams on how to connect the sensor for each of the three outputs for single or independent sensor operation.

Using Multiple Sensors in a Single System

Multiple HRXL-MaxSonar-WR sensors can be used simultaneously in the same environment with little to no interference (cross-talk). Even so, some cross-talk may still occur for users wishing to use a large number of sensors in the same environment.

If interference is occurring in the sensor setup please visit www.maxbotix.com/chaining for diagrams on correcting cross-talk between sensors.

Please take note that when the HRXL-MaxSonar-WR sensors are operating in a chaining sequence the internal free-run filter of the sensor is disabled, and the sensor will range in real-time.

Notes: ¹30mm1.5 Pipe (-7XX) does not have the additional back up FEP Teflon® seal

Real-time or triggered operation allows users to take advantage of a few functions unavailable during free run mode. When operating in triggered mode, an unfiltered maximum refresh rate can be achieved. This triggered operation allows users to range targets moving away from or closer to the sensor faster than 240mm per reading.

Analog Output Sensor Operation

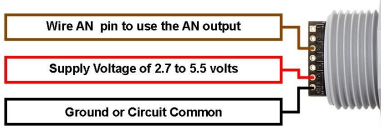

Pulse Width Output Sensor Operation

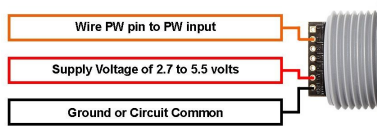

Serial Output Sensor Operation

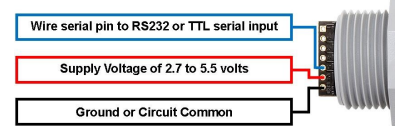

Users can enter and remain in the real-time or triggered operation by making sure that before the end each range cycle, the voltage level on Pin 4 is set low. After the sensor has completed the last reading, then Pin 4 is brought high. When Pin 4 is brought high, a brand new range cycle starts and the HRXL-MaxSonar-WR will output the most recent range data without filtering.

Analog Output Sensor Operation

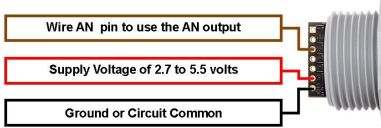

Pulse Width Output Sensor Operation

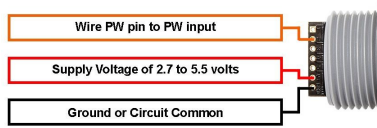

Serial Output Sensor Operation

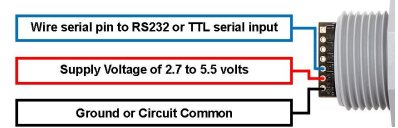

Readings during triggered operation are less accurate than the filtered operation by approximately ± 5 -mm. Because the range readings are not filtered, noise tolerance can be greatly reduced. Care should be taken to make sure that only one sensor is sampling range at a time.

Sensor minimum distance - No sensor dead zone

(MB7360, MB7369, MB7380, and MB7389)

The 5 meter sensors have a minimum reported distance of 30-cm (11.8 inches). However, the HRXL-MaxSonar-WR will report targets up to the sensor face (for the WR sensors)¹ and to within 1-mm of the front sensor face (for the WRC sensors)¹. For the 5 meter HRXL-MaxSonar-WR sensors, targets closer than 300-mm will typically range as 300-mm.

Notes: ¹ refers to section that compares WR to Alternative Packages on page 4

Sensor minimum distance - No sensor dead zone

(MB7363, MB7366, MB7368, MB7383, MB7386, and MB7388)

The 10 meter sensors have a minimum reported distance of 50-cm (19.7 inches). However, the HRXL-MaxSonar-WRL will report targets up to the sensor face. For the 10 meter HRXL-MaxSonar-WRL sensors, targets closer than 500-mm will typically range as 500-mm.

Sensor minimum distance - No sensor dead zone

(MB7375 and MB7395)

The 1.5 meter sensors have a minimum reported distance of 50-cm (19.7 inches). However, the HRXL-MaxSonar-WRB will report targets up to the sensor face. For the 1.5 meter HRXL-MaxSonar-WRB sensors, targets closer than 500-mm will typically range as 500-mm.

Sensor operation from 30-cm to 50-cm

Because of acoustic effects in the near field, objects between 30-cm and 50-cm may experience acoustic phase cancellation of the returning wave, resulting in inaccuracies of up to 5-mm. These effects become less prevalent as the target distance increases, and have not been observed past 50-cm. For this reason, users that require the highest accuracy are encouraged to mount the HRXL-MaxSonar-WR farther than 50-cm away from objects.

Range “0” location

The HRXL-MaxSonar-WR reports the range to distant targets from where the threading and nut meet on the sensor housing as shown in the diagram below.

In general, the HRXL-MaxSonar-WR will report the range to the leading edge of the closest detectable object. Target detection has been characterized in the sensor beam patterns.

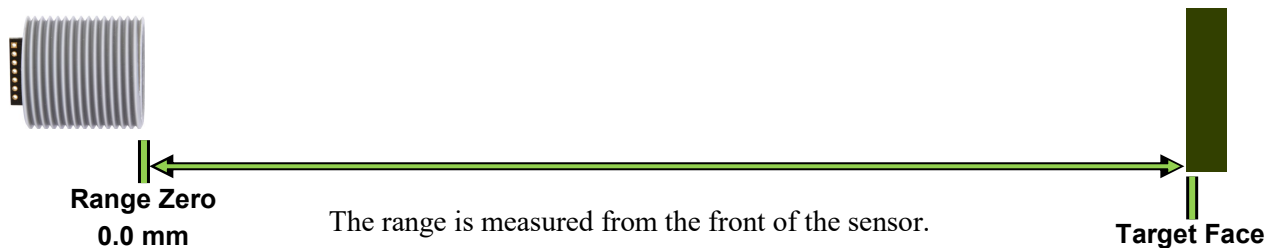
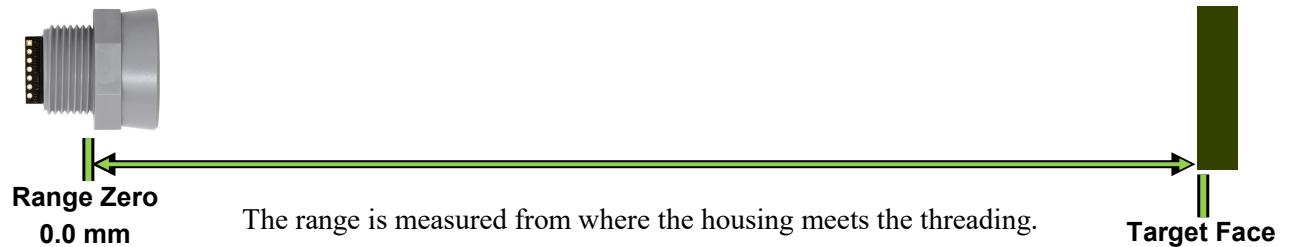
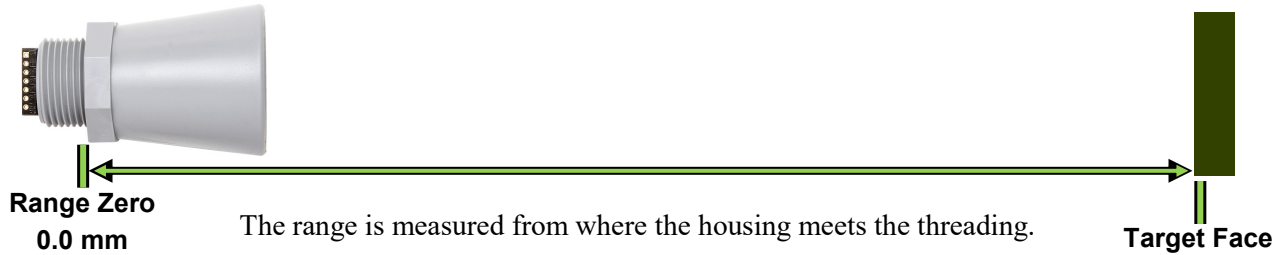

Sensor Timing Diagrams

Power Up Timing

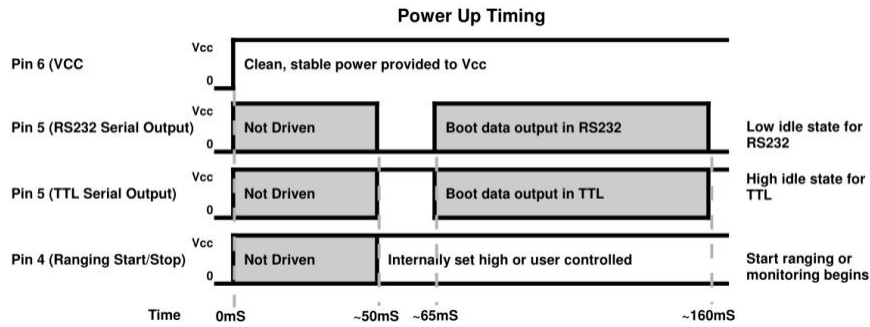

Sensor Free-Run Timing

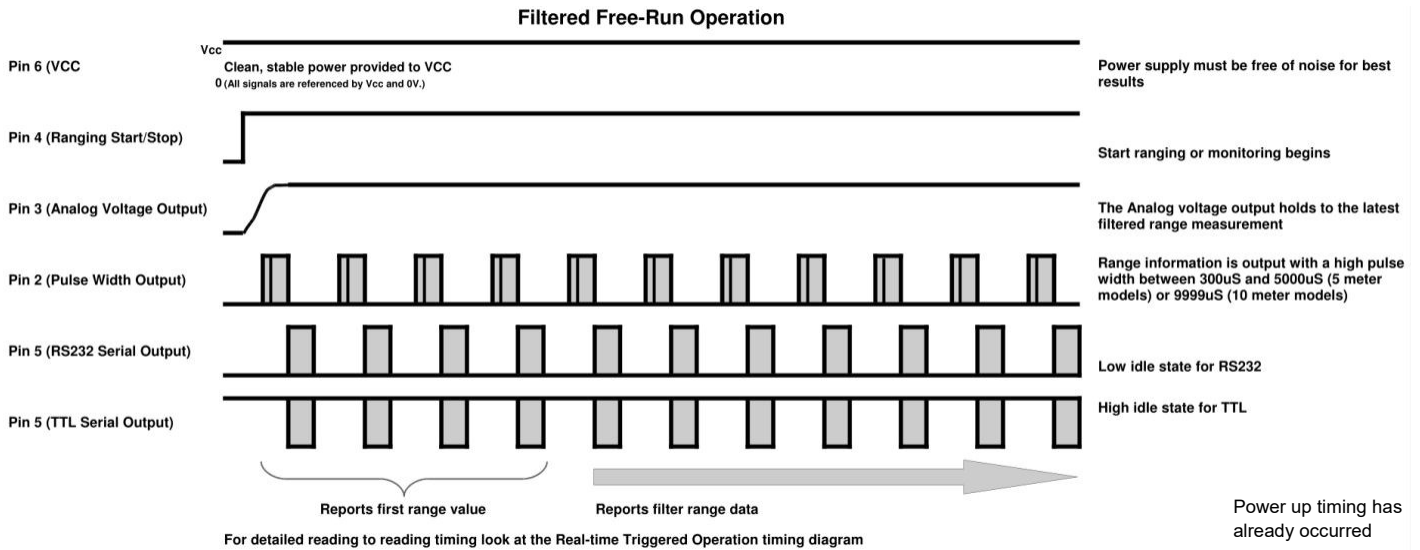

Product	Maximum Refresh Rate	Free Run Filter	Pulse Width Reported	Serial Data Reported	Pin 4 Brought Low	End of Range Cycle
MB7360, MB7367, MB7380, MB7387	7.5 Hz	1.5Hz	~118mS	~123mS	~132mS	~133mS
MB7369 and MB7389	6.67Hz	1.33Hz	~135mS	~140mS	~147mS	~148mS
MB7363, MB7366, MB7383, MB7386	6Hz	1.2Hz	~148mS	~158mS	~165mS	~166mS
MB7368 and MB7388	5.56Hz	1.11Hz	~163mS	~173mS	~180mS	~181mS
MB7375 and MB7395	6.33Hz	1.26Hz	~148mS	~150mS	~157mS	~158mS

When operating in free run mode, the HRXL-MaxSonar-WR sensors are designed to be used in a variety of outdoor, industrial, or indoor environments. Many acoustic noise sources will have little to no effect on the reported range of the HRXL-MaxSonar-WR sensors¹. Most range readings are accurately reported¹. If the range readings are affected, the effect is typically less than 5-mm¹. This allows users to employ real-time ultrasonic distance sensing without the need for additional supporting circuitry or complicated user software.

The HRXL-MaxSonar-WR use an internal filter to process range data. This filter improves the sensor’s performance for accuracy, noise rejection, and reading to reading stability. The filtering in the free-run operation also permits additional acoustic and electrical noise tolerance.

On the HRXL-MaxSonar-WR sensors, when pin 4 is left high, the sensor will continue to range, the data output includes a filter for increased accuracy in environments with acoustic noise. The HRXL-MaxSonar-WR sensors will output the range based on recent range information. The filter does not affect the speed at which data is made available to the user but instead allows for more consistent range information to be presented.

Notes: ¹ Refer to section that compares WR to WRC on page 4

Sensor Timing Diagrams Cont.

Triggered—Real-time Operation Timing

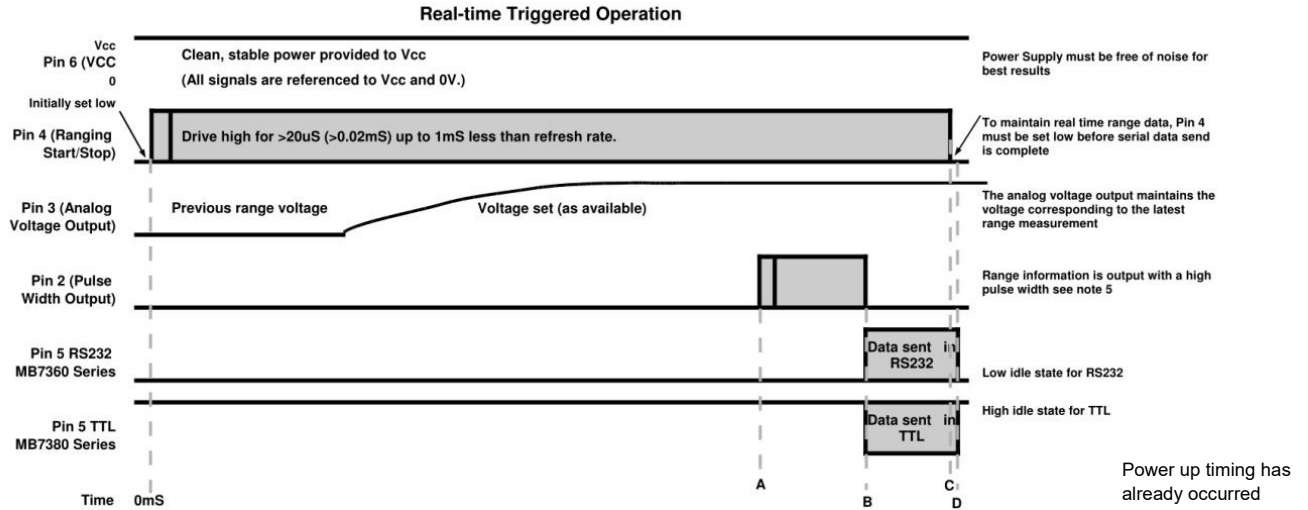

Product	Maximum Refresh Rate	Pulse Width sent (A)	Serial Data sent (B)	RX Pin set low (C)	End of range cycle (D)
MB7360, MB7367, MB7380, MB7387	7.5 Hz	~118mS	~123mS	~132mS	~133mS
MB7369 and MB7389	6.67Hz	~135mS	~140mS	~147mS	~148mS
MB7363, MB7366, MB7383, MB7386	6Hz	~148mS	~158mS	~165mS	~166mS
MB7368 and MB7388	5.17Hz	~163mS	~173mS	~180mS	~181mS
MB7375 and MB7395	6.33Hz	~148mS	~150mS	~157mS	~158mS

Pulse Width data sent (Column A) - Column A shows the approximate time that the sensor starts to output the pulse width data. The Pulse Width output time can be as short as 300uS (minimum reported distance). For 5 meter sensors, the pulse width can take as long as 5000uS (maximum reported distance) to be sent. For 10 meter sensors the Pulse Width can take as long as 9999uS (maximum reported distance) to be sent.

Serial data sent (Column B) - Column B shows the approximate time during each range cycle when the serial data is output for the sensor. Range data takes ~8mS to be reported from the serial data output.

RX Pin set low (Column C) - When operating the HRXL-MaxSonar-WR in Triggered Operation, Pin 4 is must be brought high for a time frame greater than 20uS (0.02mS) and less than the time in Column C in the chart above. If Pin 4 remains high for a period of time greater than the value in Column C, the sensor will switch into free-run filter operation.

End of Range Cycle (Column D) - Column D shows the approximate time each range cycle takes to complete for each sensor.

Temperature Compensation On Board – Internal Temperature Compensation

The speed of sound in air increases by about 0.6 meters per second, per degree centigrade. Because of this, each HRXL-MaxSonar-WR is equipped with an internal temperature sensor which allows the sensor to apply compensation for speed of sound changes.

The actual air temperature of the path between the sensor and the target may not match the temperature measured at the sensor itself. Sensors can be mounted in vertical applications, or applications where the environment temperature gradient is severe. These users may experience a temperature measurement error which will affect the sensor accuracy. For example, buildings with a height of 3-meters can have floor to ceiling temperature variations of 5°C or more.

Because of these temperature effects, users desiring the highest accuracy output are encouraged to use a properly mounted external temperature sensor or to manually account for this measurement error.

HR-MaxTemp, an External Temperature Sensor

Although the HRXL-MaxSonar-WR has an internal temperature sensor; for best accuracy, users are encouraged to use the optional external temperature sensor. On power-up, the HRXL-MaxSonar-WR will automatically detect an attached HR-MaxTemp temperature sensor and begin to apply temperature compensation using the external temperature sensor.

The external temperature sensor allows for the most accurate temperature compensation, by allowing temperature readings to be taken that better reflect the composite temperature of the acoustic ranging path. For best results, users are encouraged to connect the temperature sensor midway between the HRXL-MaxSonar-WR and the expected target.

Voltage vs Temperature

The graphs below show minimum operating voltage of the sensor verses temperature.

The graph pictured below is applicable to the following sensors:

MB7360, MB7369, MB7380 & MB7389

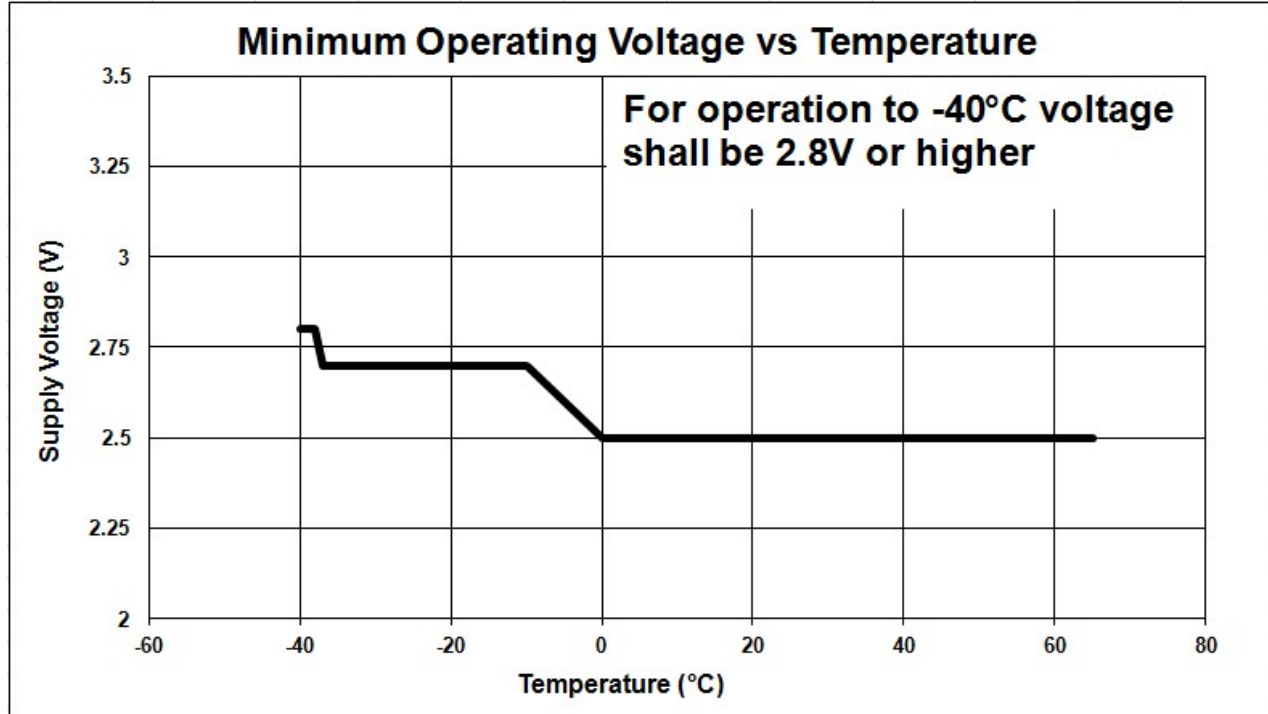

Voltage vs Temperature

The graph pictured below is applicable to the following sensors:

MB7363, MB7366, MB7368, MB7375, MB7383, MB7386, MB7388 & MB7395

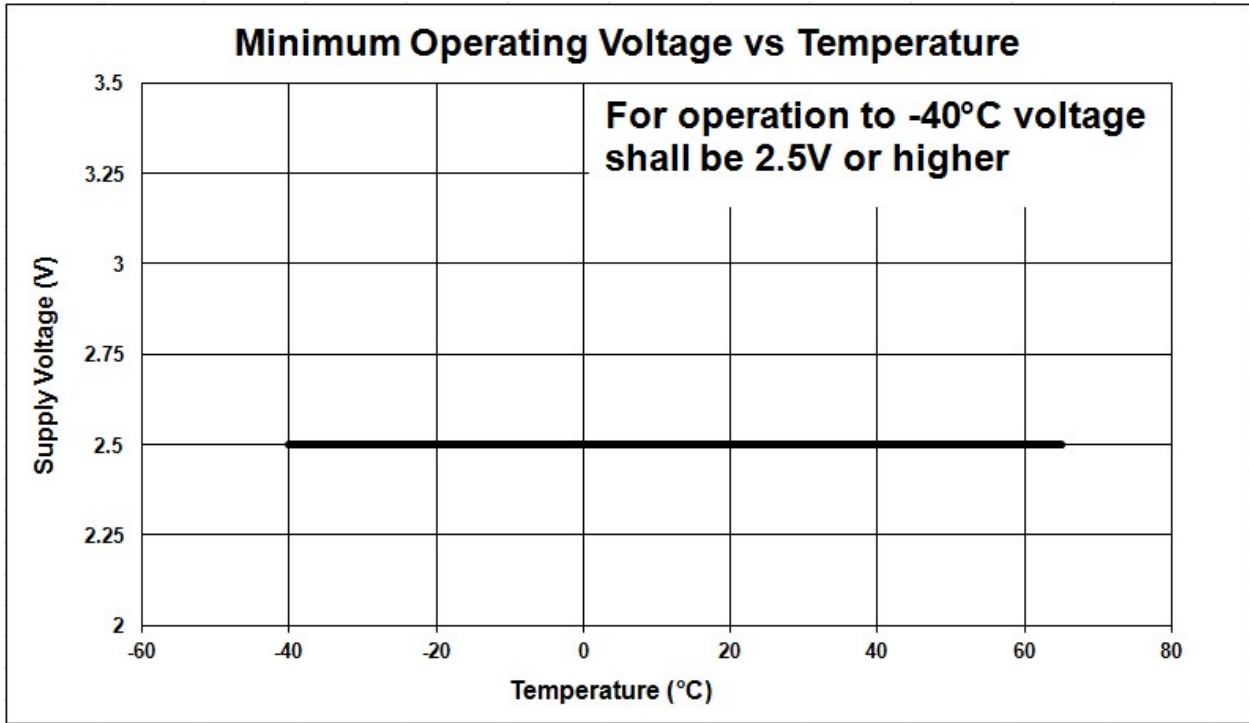

The graph pictured below is applicable to the following sensors:

**MB7367-WRC, MB7367-1" NPS, MB7367-1" BSPP, MB7367-30mm1.5
 MB7369-WRC, MB7369-1" NPS, MB7369-1" BSPP, MB7369-30mm1.5
 MB7387-WRC, MB7387-1" NPS, MB7387-1" BSPP, MB7387-30mm1.5
 MB7389-WRC, MB7389-1" NPS, MB7389-1" BSPP, MB7389-30mm1.5**

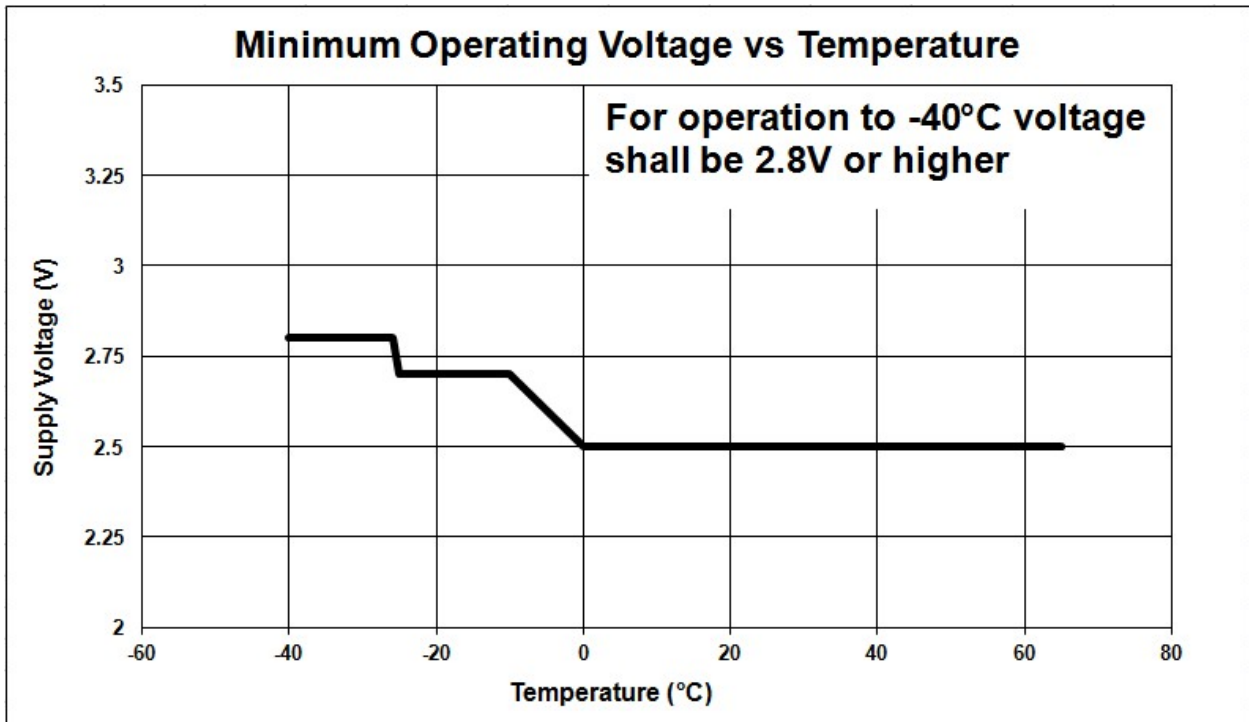

Attenuation of Ultrasound

Attenuation, specifically absorption of sound through the air, restricts the maximum range of ultrasonic rangefinders. As sound waves travel through the air, that air absorbs some of their energy. High frequency sounds like ultrasound are often attenuated more quickly than lower frequency sounds. In addition to frequency, relative humidity also affect attenuation. Warm air masses with low relative humidity will typically attenuate sound waves faster. As such performance of ultrasonic devices may be limited at low relative humidity, especially when trying to detect targets at longer ranges.

Background Information Regarding our Beam Patterns

Each HRXL-MaxSonar-WR sensor has a calibrated beam pattern. Each sensor is matched to provide the approximate detection pattern shown in this datasheet. This allows end users to select the part number that matches their given sensing application. Each part number has a consistent field of detection so additional units of the same part number will have similar beam patterns. The beam plots are provided to help identify an estimated detection zone for an application based on the acoustic properties of a target versus the plotted beam patterns.

Each beam pattern is a 2D representation of the detection area of the sensor. The beam pattern is actually shaped like a 3D cone (having the same pattern both vertically and horizontally). Beam patterns for dowels are used to show the beam pattern of each sensor. Dowels are long cylindrical targets of a given diameter. The dowels provide consistent target detection characteristics for a given size target which allows easy comparison of one MaxSonar sensor to another MaxSonar sensor.

For each part number, the four patterns (A, B, C, and D) represent the detection zone for a given target size. Each beam pattern shown is determined by the sensor's part number and target size.

The actual beam angle changes over the full range. Use the beam pattern for a specific target at any given distance to calculate the beam angle for that target at the specific distance. Generally, smaller targets are detected over a narrower beam angle and a shorter distance. Larger targets are detected over a wider beam angle and a longer distance.

People Sensing:
For users that desire to detect people, the detection area to the 1-inch diameter dowel, in general, represents the area that the sensor will reliably detect people.

Beam Pattern Target Shapes

- A 6.1-mm (0.25-inch) diameter dowel 4ft length
- B 2.54-cm (1-inch) diameter dowel 4ft length
- C 8.89-cm (3.5-inch) diameter dowel 4ft length
- D 11-inch wide board 4ft in length moved left to right with the board parallel to the front sensor face. This shows the sensor's range capability.

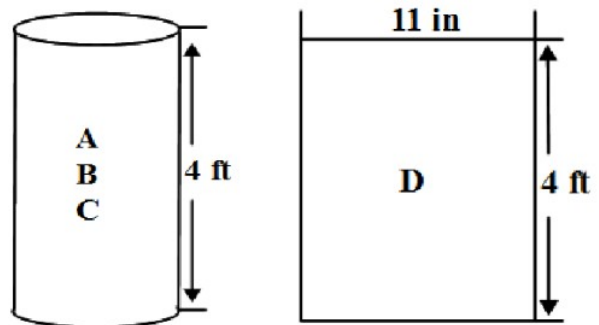

Corner Reflectors

Sometimes when using an ultrasonic sensor, users experience detection of unwanted objects that appear outside the expected beam pattern. These types of detections are the result of reflectors present in the environment. Corner reflectors can be surprisingly small, yet present a large reflection back to the sensor. Certain objects are prone to causing corner reflections. One of the most common corner reflectors is two flat surfaces joining together to create a 90° angle. A half-circle also acts as a similar reflector. You can learn more about corner reflectors in our [Cube Corner Reflectors](#) article.

MB7360-MB7380 HRXL-MaxSonar® -WR™ Beam Pattern and Uses

The HRXL-MaxSonar-WR product line has a narrow sensor beam and provides reliable long range detection zones.

MB7360-1XX MB7380-1XX

HRXL-MaxSonar® -WR/WRT™ Beam Pattern

Sample results for measured beam pattern are shown on a 30-cm grid. The detection pattern is shown for dowels of varying diameters that are placed in front of the sensor.

A 6.1-mm (0.25-inch) diameter dowel

B 2.54-cm (1-inch) diameter dowel

C 8.89-cm (3.5-inch) diameter dowel

D 11-inch wide board moved left to right with the board parallel to the front sensor face.

This shows the sensor's range capability.

Note: For people detection the pattern typically falls between charts A and B.

■ Partial Detection

— 5.0 V

● 3.3 V

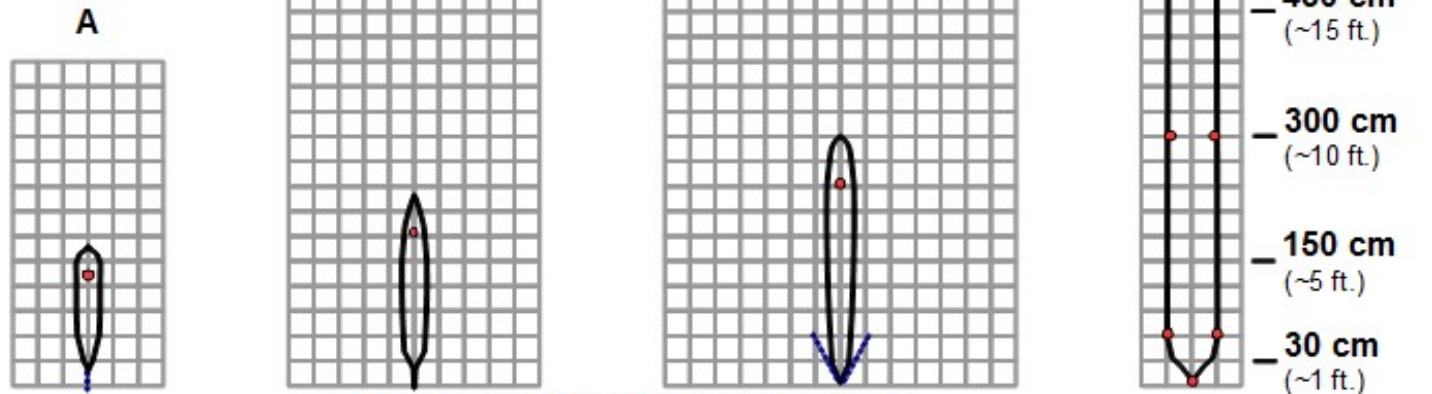

Beam Characteristics are Approximate

Beam Pattern drawn to a 1:95 scale for easy comparison to our other products.

MB7360-MB7380

Features and Benefits

- Factory calibrated beam width
- Low operating voltages from 2.7V to 5.5V
- All range outputs are active simultaneously
- High acoustic sensitivity

MB7360-MB7380

Applications and Uses

- Autonomous Navigation
- Robot Ranging Sensor
- Bin Level Measurement
- Tank Level Measurement

MB7363-MB7383 HRXL-MaxSonar® -WRLS™ Beam Pattern and Uses

The HRXL-MaxSonar-WRLS sensors are 10 meter sensors with a higher sensitivity than other HRXL-MaxSonar-WR products. This sensor is recommended for applications in which objects do not reflect enough ultrasonic sound for other sensors to report the range to, such as people.

MB7363-1XX MB7383-1XX

HRXL-MaxSonar® -WRLS/WRLST™ Beam Pattern

Sample results for measured beam pattern are shown on a 30-cm grid. The detection pattern is shown for dowels of varying diameters that are placed in front of the sensor

- A 6.1-mm (0.25-inch) diameter dowel
- B 2.54-cm (1-inch) diameter dowel
- C 8.89-cm (3.5-inch) diameter dowel
- D 11-inch wide board moved left to right with the board parallel to the front sensor face. This shows the sensor's range capability.

- Partial Detection
- 5.0 V
- 3.3 V
- 2.7 V

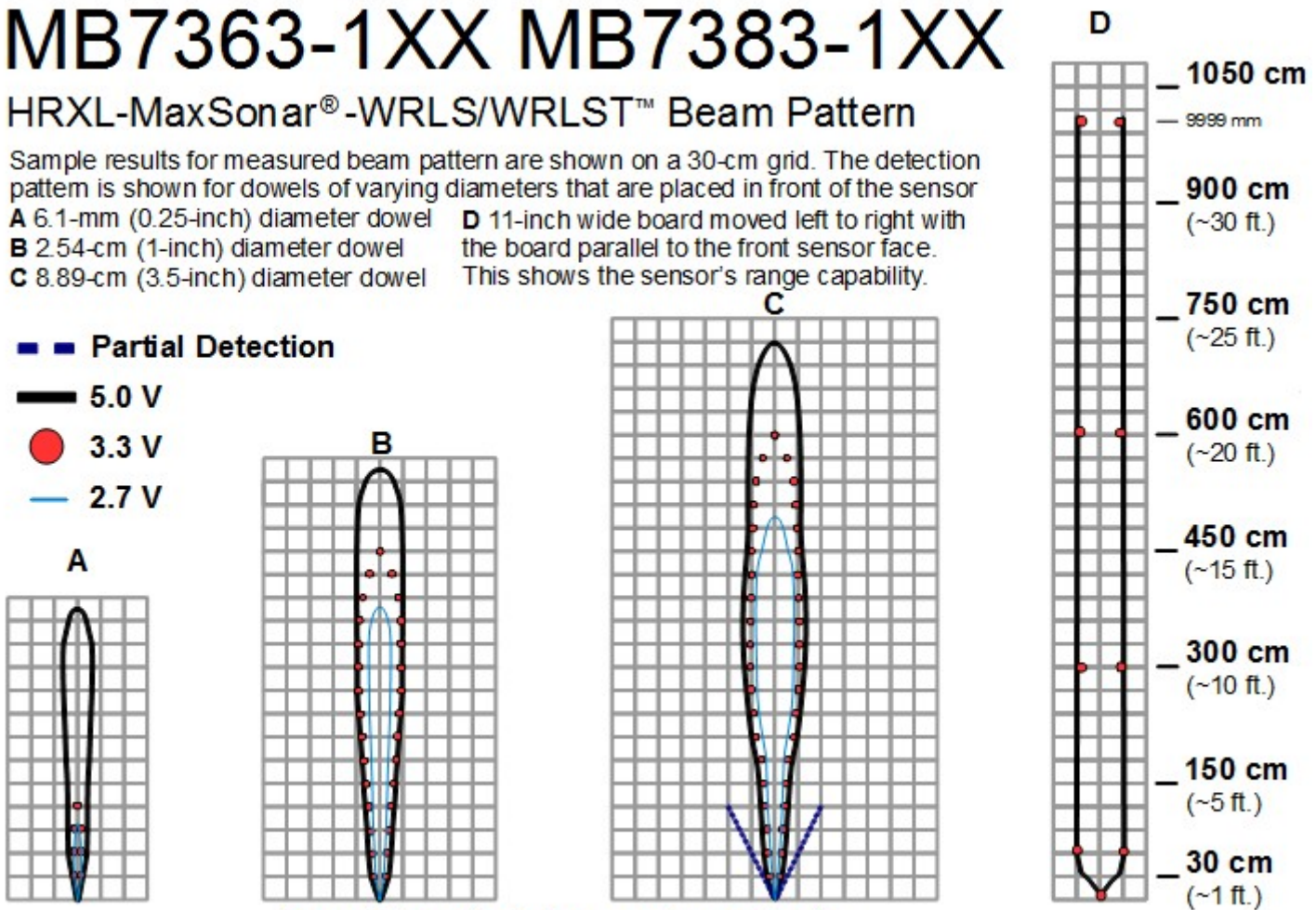

Beam Characteristics are Approximate

Beam Pattern drawn to a 1:95 scale for easy comparison to our other products.

MB7363-MB7383

Features and Benefits

- Factory calibrated beam width
- Low operating voltages from 2.7V to 5.5V
- All range outputs are active simultaneously
- High acoustic sensitivity

MB7363-MB7383

Applications and Uses

- Autonomous Navigation
- Robot Ranging Sensor
- Bin Level Measurement
- Tank Level Measurement

MB7363-8XX MB7383-8XX

HRXL-MaxSonar®-WRLS/WRLST™ Beam Pattern

Sample results for measured beam pattern are shown on a 30-cm grid. The detection Pattern is shown for dowels of varying diameters that are placed in front of the sensor.

A 6.1-mm (0.25-inch) diameter dowel

B 2.54-cm (1-inch) diameter dowel

C 8.89-cm (3.5-inch) diameter dowel

D 11-inch wide board with the board parallel to the front sensor face.

This shows the sensor's range capability.

Note: For people detection the pattern typically falls between charts A and B.

- 5.0V
- 3.3V
- 2.7V

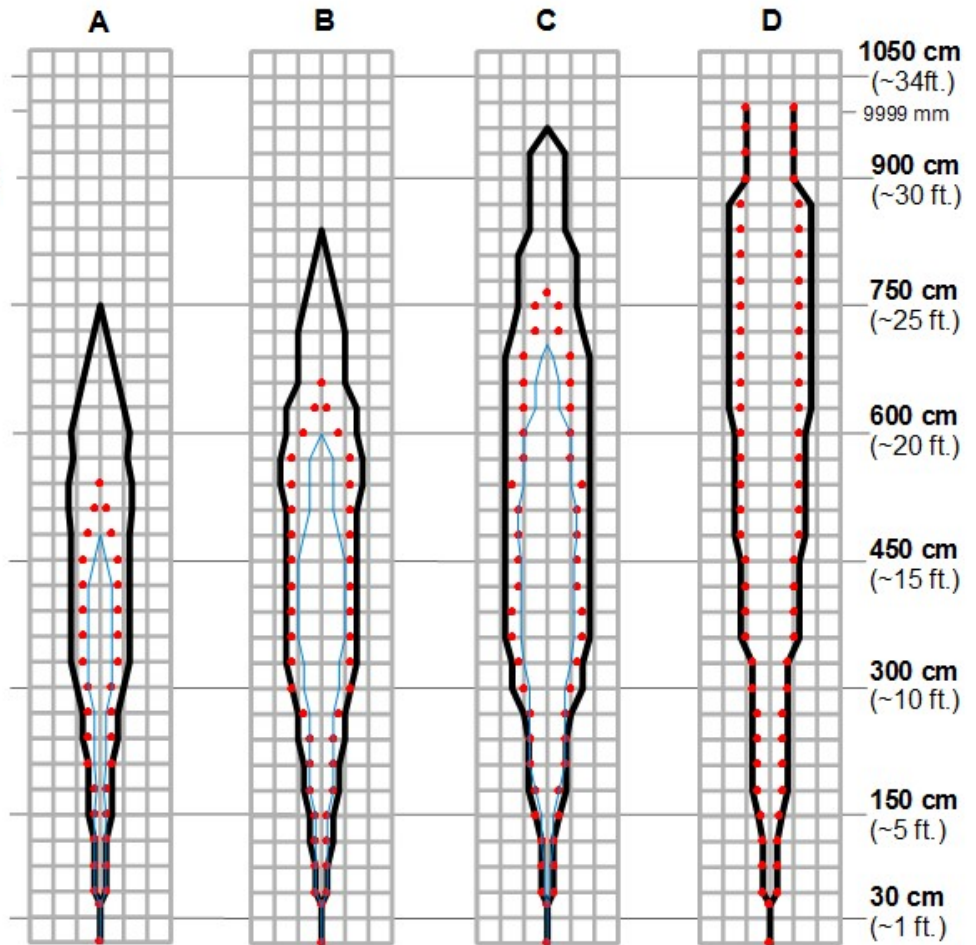

Beam Characteristics are Approximate

Beam Pattern drawn to a 1:95 scale for easy comparison to our other products.

MaxBotix® Inc. For more information or latest product datasheets visit: www.maxbotix.com
 The names MaxBotix, MaxSonar, EZ0, EZ1, EZ2, EZ3, EZ4, AE0, AE1, AE2, AE3, AE4, and WR1 are trademarks of MaxBotix Inc.

MB7366-MB7386 HRXL-MaxSonar® -WRL™ Beam Pattern and Uses

The HRXL-MaxSonar-WRL sensors are a long range, 10 meter ultrasonic sensor.

MB7366-1XX MB7386-1XX

HRXL-MaxSonar® -WRL/WRLT™ Beam Pattern

Sample results for measured beam pattern are shown on a 30-cm grid. The detection pattern is shown for dowels of varying diameters that are placed in front of the sensor

- A 6.1-mm (0.25-inch) diameter dowel
- B 2.54-cm (1-inch) diameter dowel
- C 8.89-cm (3.5-inch) diameter dowel

D 11-inch wide board moved left to right with the board parallel to the front sensor face.

This shows the sensor's range capability.

Note: For people detection the pattern typically falls between charts A and B.

■ ■ Partial Detection

— 5.0 V

● 3.3 V

— 2.7 V

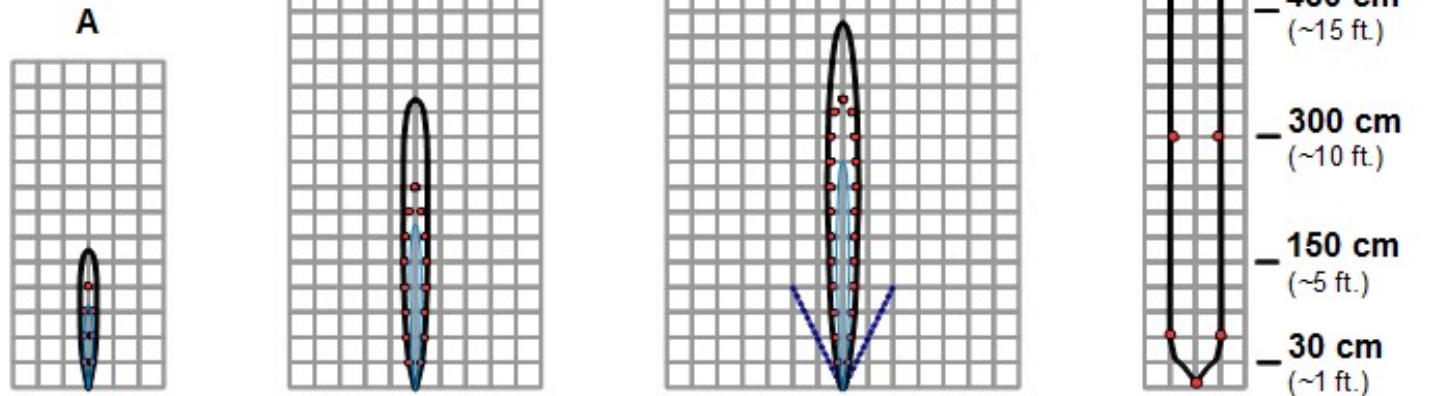

Beam Characteristics are Approximate

Beam Pattern drawn to a 1:95 scale for easy comparison to our other products.

MB7366-MB7386

Features and Benefits

- Factory calibrated beam width
- Low operating voltages from 2.7V to 5.5V
- All range outputs are active simultaneously
- 10 meter range to large targets

MB7366-MB7386

Applications and Uses

- Autonomous Navigation
- Robot Ranging Sensor
- Bin Level Measurement
- Tank Level Measurement
- Long Range Measurement

MB7366-8XX MB7386-8XX

HRXL-MaxSonar®-WRL/WRLT™ Beam Pattern

Sample results for measured beam pattern are shown on a 30-cm grid. The detection Pattern is shown for dowels of varying diameters that are placed in front of the sensor.

A 6.1-mm (0.25-inch) diameter dowel

B 2.54-cm (1-inch) diameter dowel

C 8.89-cm (3.5-inch) diameter dowel

D 11-inch wide board with the board parallel to the front sensor face.

This shows the sensor's range capability.

Note: For people detection the pattern typically falls between charts A and B.

- 5.0V
- 3.3V
- 2.7V

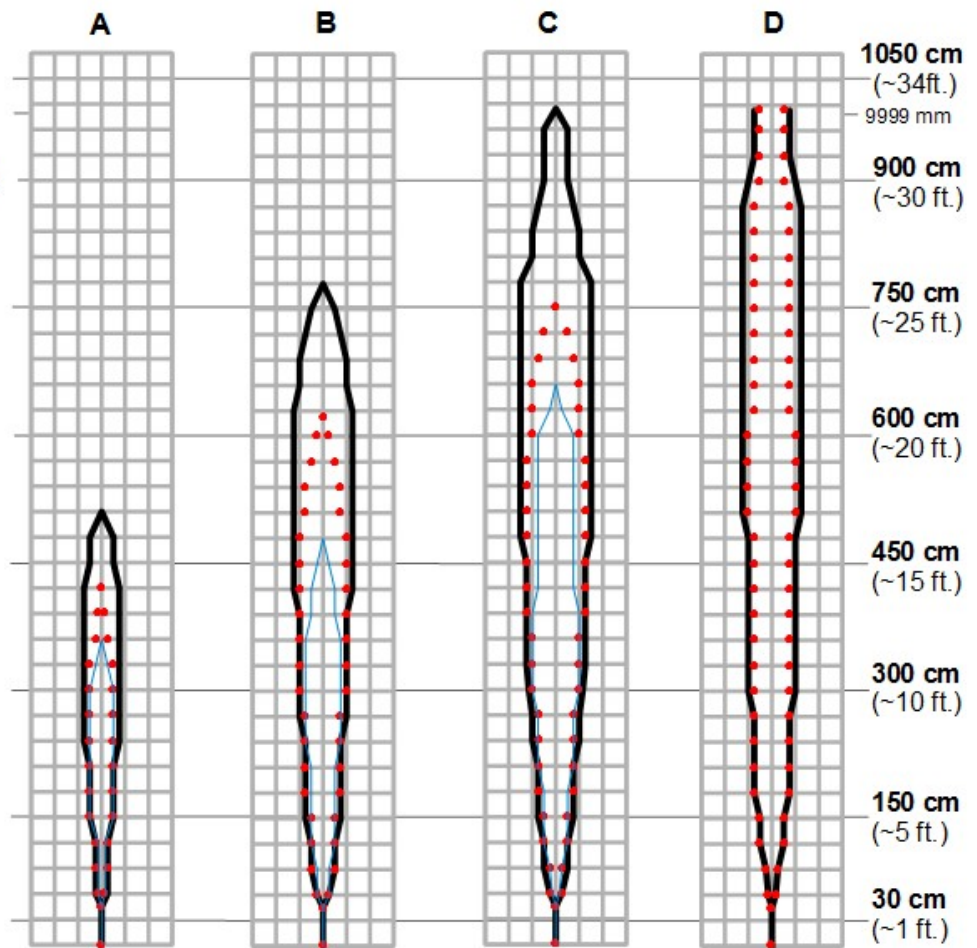

Beam Characteristics are Approximate

Beam Pattern drawn to a 1:95 scale for easy comparison to our other products.

MaxBotix® Inc.

For more information or latest product datasheets visit: www.maxbotix.com

The names MaxBotix, MaxSonar, EZ0, EZ1, EZ2, EZ3, EZ4, AE0, AE1, AE2, AE3, AE4, and WR1 are trademarks of MaxBotix Inc.

MB7368-MB7388 HRXL-MaxSonar® -WRML™ Beam Pattern and Uses

The HRXL-MaxSonar-WRML sensors are a long range, most 10 meter ultrasonic sensor with advance filtering that ranges to targets with the largest ultrasonic reflection, while ignoring smaller clutter.

MB7368-1XX MB7388-1XX

HRXL-MaxSonar®-WRML/WRMLT™ Beam Pattern

Sample results for measured beam pattern are shown on a 30-cm grid. The detection pattern is shown for dowels of varying diameters that are placed in front of the sensor.

A 6.1-mm (0.25-inch) diameter dowel

B 2.54-cm (1-inch) diameter dowel

C 8.89-cm (3.5-inch) diameter dowel

Partial Detection

5.0V

3.3V

2.7V

D 11-inch wide board moved left to right with the board parallel to the front sensor face.

This shows the sensor's range capability.

Note: For people detection the pattern typically falls between charts A and B.

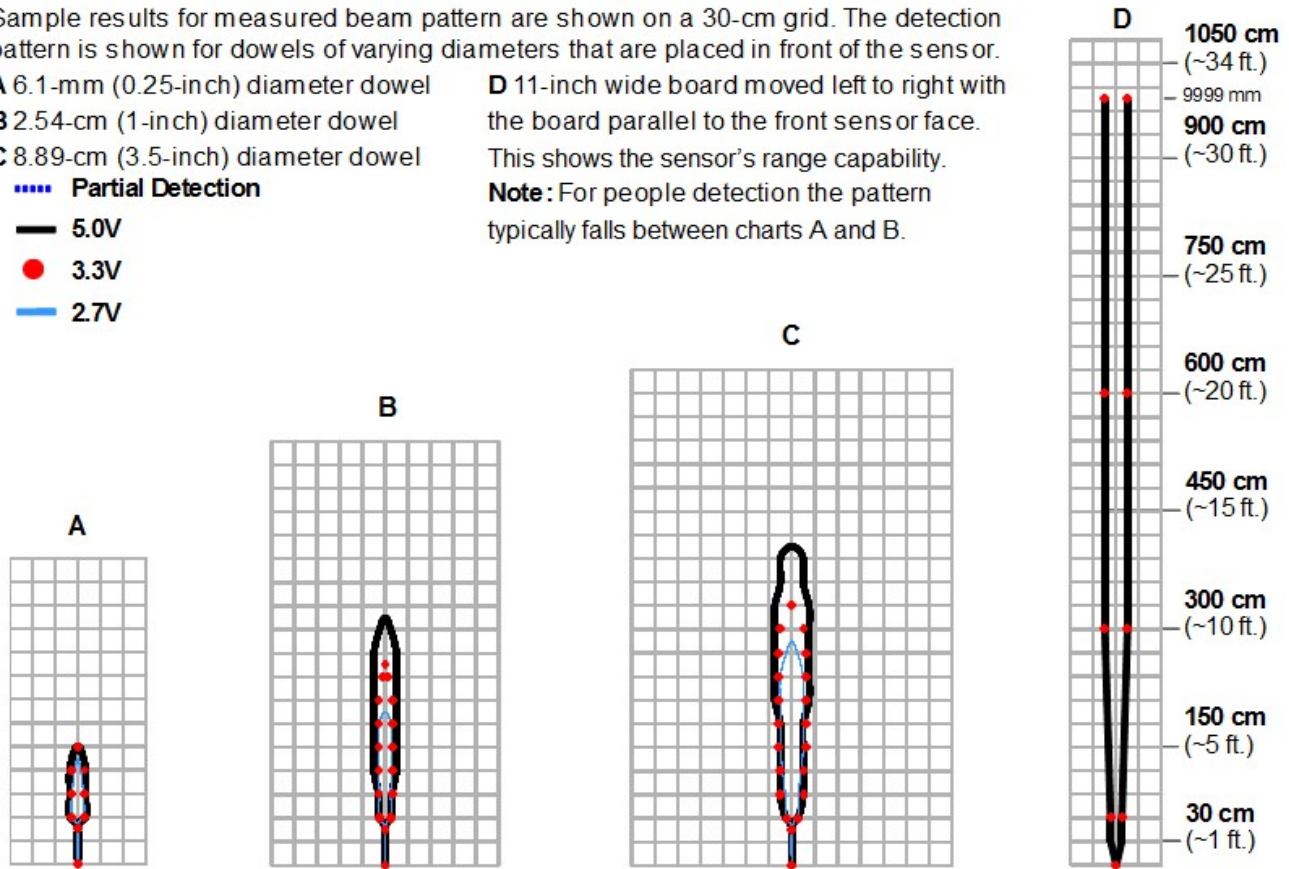

Beam Characteristics are Approximate

Beam Pattern drawn to a 1:95 scale for easy comparison to our other products.

MB7368-MB7388

Features and Benefits

- Factory calibrated beam width
- Low operating voltages from 2.7V to 5.5V
- All range outputs are active simultaneously
- 10 meter range to large targets

MB7368-MB7388

Applications and Uses

- Bin Level Measurement
- Tank Level Measurement
- Long Range Measurement

MB7368-8XX MB7388-8XX

HRXL-MaxSonar®-WRML/WRMLT™ Beam Pattern

Sample results for measured beam pattern are shown on a 30-cm grid. The detection Pattern is shown for dowels of varying diameters that are placed in front of the sensor.

A 6.1-mm (0.25-inch) diameter dowel

B 2.54-cm (1-inch) diameter dowel

C 8.89-cm (3.5-inch) diameter dowel

D 11-inch wide board with the board parallel to the front sensor face.

This shows the sensor's range capability.

Note: For people detection the pattern typically falls between charts A and B.

- 5.0V
- 3.3V
- 2.7V

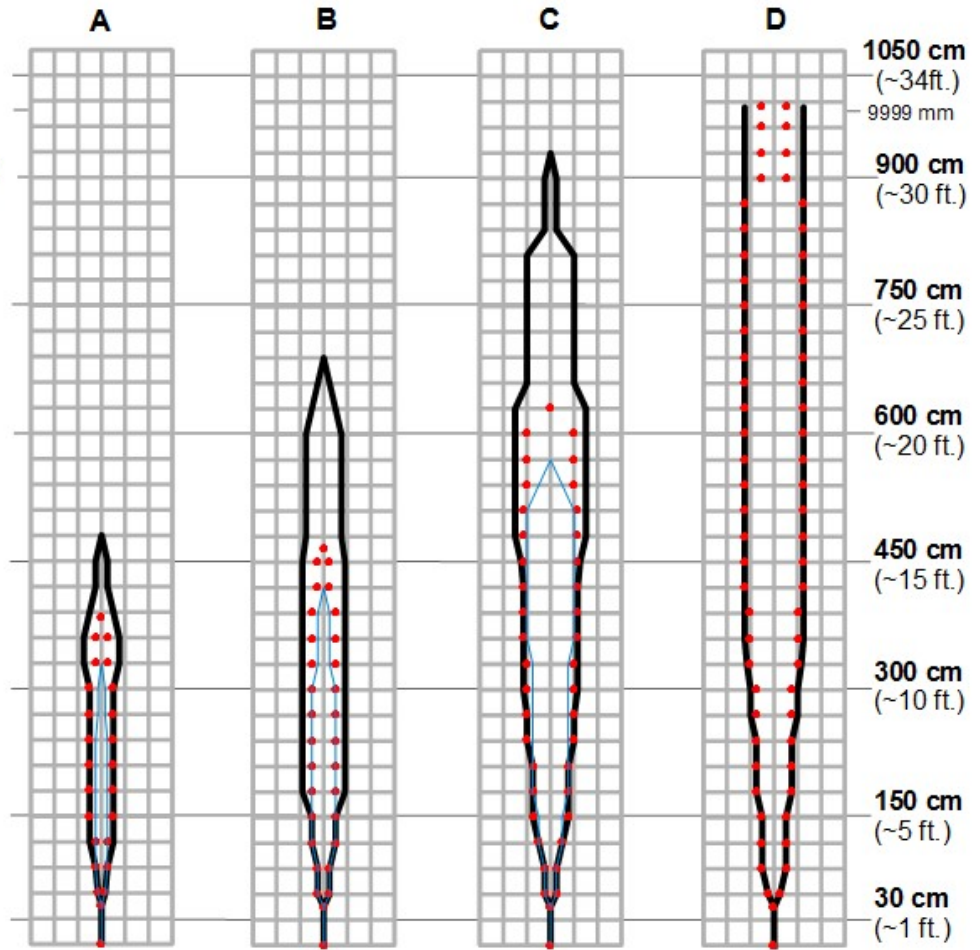

Beam Characteristics are Approximate

Beam Pattern drawn to a 1:95 scale for easy comparison to our other products.

MaxBotix® Inc.

For more information or latest product datasheets visit: www.maxbotix.com

The names MaxBotix, MaxSonar, EZ0, EZ1, EZ2, EZ3, EZ4, AE0, AE1, AE2, AE3, AE4, and WR1 are trademarks of MaxBotix Inc.

MB7369-MB7389 HRXL-MaxSonar® -WRM™ Beam Pattern and Uses

The HRXL-MaxSonar-WRM product line has a narrow sensor beam and advance filtering that ranges to targets with the largest ultrasonic reflection, while ignoring smaller clutter.

MB7369-1XX MB7389-1XX

HRXL-MaxSonar® -WRM/WRMT™ Beam Pattern

Sample results for measured beam pattern are shown on a 30-cm grid. The detection pattern is shown for dowels of varying diameters that are placed in front of the sensor.

- A 6.1-mm (0.25-inch) diameter dowel
- B 2.54-cm (1-inch) diameter dowel
- C 8.89-cm (3.5-inch) diameter dowel

D 11-inch wide board moved left to right with the board parallel to the front sensor face. This shows the sensor's range capability.

Note: For people detection the pattern typically falls between charts A and B.

■ Partial Detection

— 5.0 V

● 3.3 V

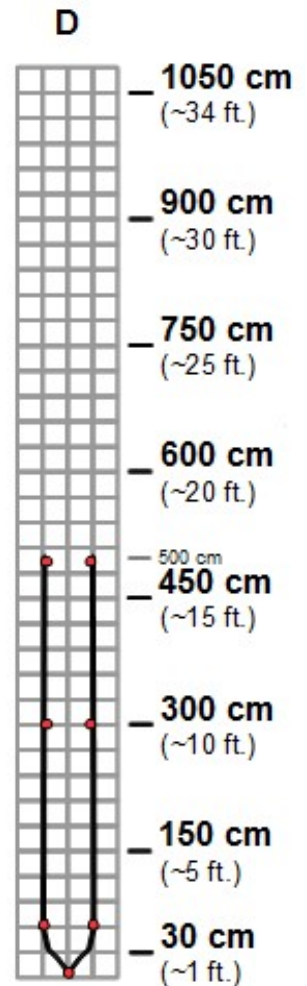
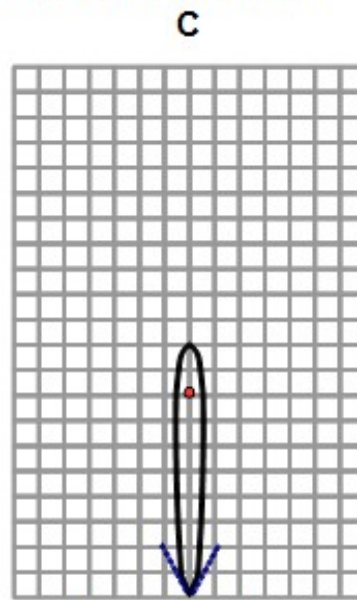
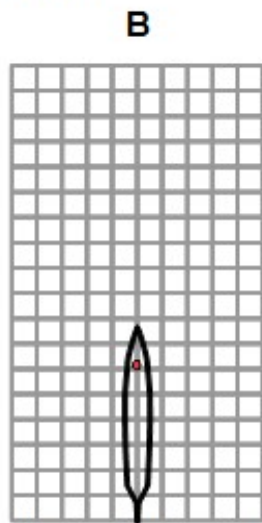
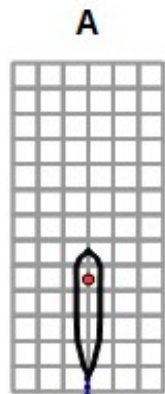

Beam Characteristics are Approximate

Beam Pattern drawn to a 1:95 scale for easy comparison to our other products.

MB7369-MB7389

Features and Benefits

- Factory calibrated beam width
- Low operating voltages from 2.7V to 5.5V
- All range outputs are active simultaneously
- Superior clutter rejection

MB7369-MB7389

Applications and Uses

- Bin Level Measurement
- Tank Level Measurement

MB736X-MB738X HRXL-MaxSonar-WRC Beam Pattern and Uses

The HRXL-MaxSonar-WRC sensor product line has select models that are available in alternative housings that include a compact WRC form factor, 1" NPS pipe threading, 1" BSPP pipe threading, and 30mm 1.5 pipe threading.

MB7360-2XX	MB7369-2XX	MB7380-2XX	MB7389-2XX
MB7360-5XX	MB7369-5XX	MB7380-5XX	MB7389-5XX
MB7360-6XX	MB7369-6XX	MB7380-6XX	MB7389-6XX
MB7360-7XX	MB7369-7XX	MB7380-7XX	MB7389-7XX

HRXL-MaxSonar® -Beam Pattern

Sample results for measured beam pattern are shown on a 30-cm grid. The detection pattern is shown for dowels of varying diameters that are placed in front of the sensor.

- A 6.1-mm (0.25-inch) diameter dowel
- B 2.54-cm (1-inch) diameter dowel
- C 8.89-cm (3.5-inch) diameter dowel

D 11-inch wide board moved left to right with the board parallel to the front sensor face. This shows the sensor's range capability.

Note: For people detection the pattern typically falls between charts A and B.

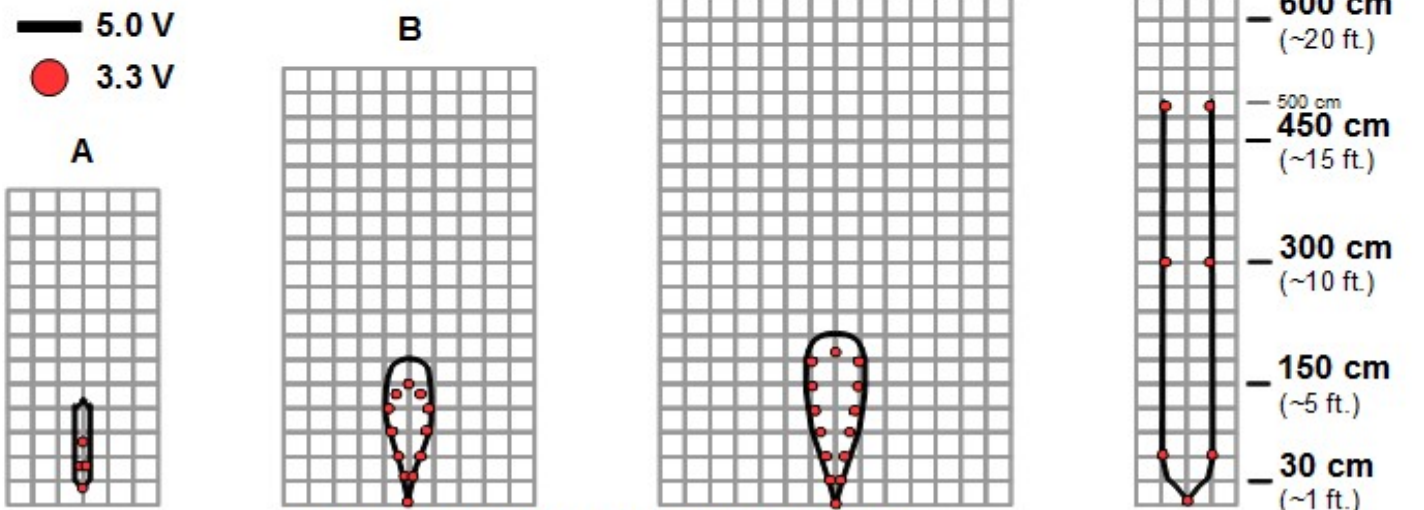

Beam Characteristics are Approximate

Beam Pattern drawn to a 1:95 scale for easy comparison to our other products.

MB736X-MB738X Features and Benefits

- Extra Compact Housing
- Designed for outdoor or indoor environments
- Lightweight, compact, weather resistant design
- Low cost IP67 sensor
- Reliable and stable range data

MB736X-MB738X Applications and Uses

- Applications with threaded pipe mounting

MB7375-MB7395 HRXL-MaxSonar-WRB/WRBT Beam Pattern and Uses

The HRXL-MaxSonar-WRB sensors are the 1.525-meter (5-foot) wide beam versions of HRXL-MaxSonar-WRML sensors. The HRXL-MaxSonar-WRB sensor product line has select models that are available in alternative housings that include a compact WRC form factor, 1” NPS pipe threading, 1” BSPP pipe threading, and 30mm 1.5 pipe threading.

- MB7375-2XX MB7395-2XX**
- MB7375-5XX MB7395-5XX**
- MB7375-6XX MB7395-6XX**
- MB7375-7XX MB7395-7XX**

HRXL-MaxSonar®-WRB/WRBT™ Beam Pattern

Sample results for measured beam pattern are shown on a 30-cm grid. The detection pattern is shown for dowels of varying diameters that are placed in front of the sensor.

- A** 6.1-mm (0.25-inch) diameter dowel
- B** 2.54-cm (1-inch) diameter dowel
- C** 8.89-cm (3.5-inch) diameter dowel

D 11-inch wide board moved left to right with the board parallel to the front sensor face. This shows the sensor’s range capability.

- ⋯ **Partial Detection**
- **5.0V**
- **3.3V**
- **2.7V**

Note: For people detection the pattern typically falls between charts A and B.
Max distance is 1525 mm

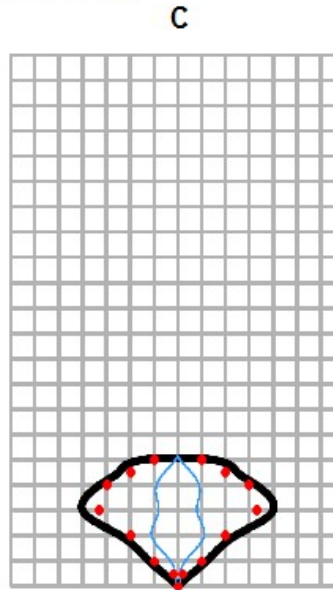
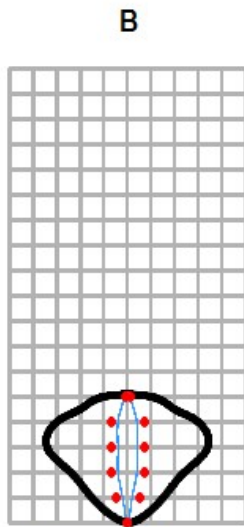
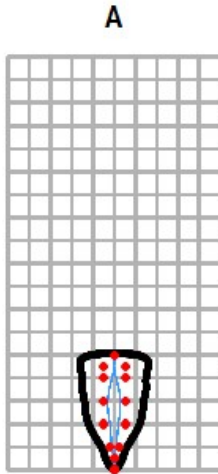
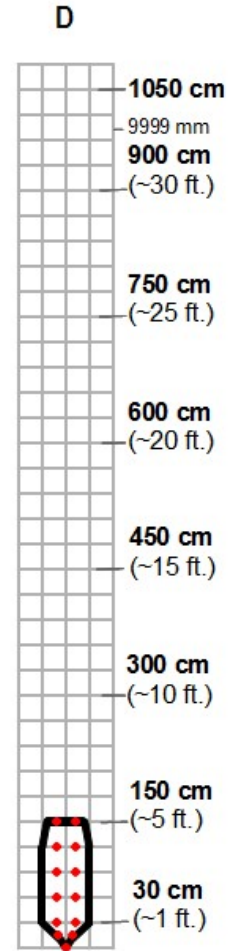

Beam Characteristics are Approximate

Beam Pattern drawn to a 1:95 scale for easy comparison to our other products.

MB7375-MB7395 Features and Benefits

- Wide Beam
- Extra Compact Housing
- Designed for outdoor or indoor environments
- Lightweight, compact, weather resistant design
- Low cost IP67 sensor
- Reliable and stable range data

MB7375-MB7395 Applications and Uses

- Applications with threaded pipe mounting

Part Numbers

All part numbers are a combination of a six-character base followed by a dash and a three-digit product code. Please review the following table for more information on the three-digit product code.

Note: Active part numbers listed on page 26

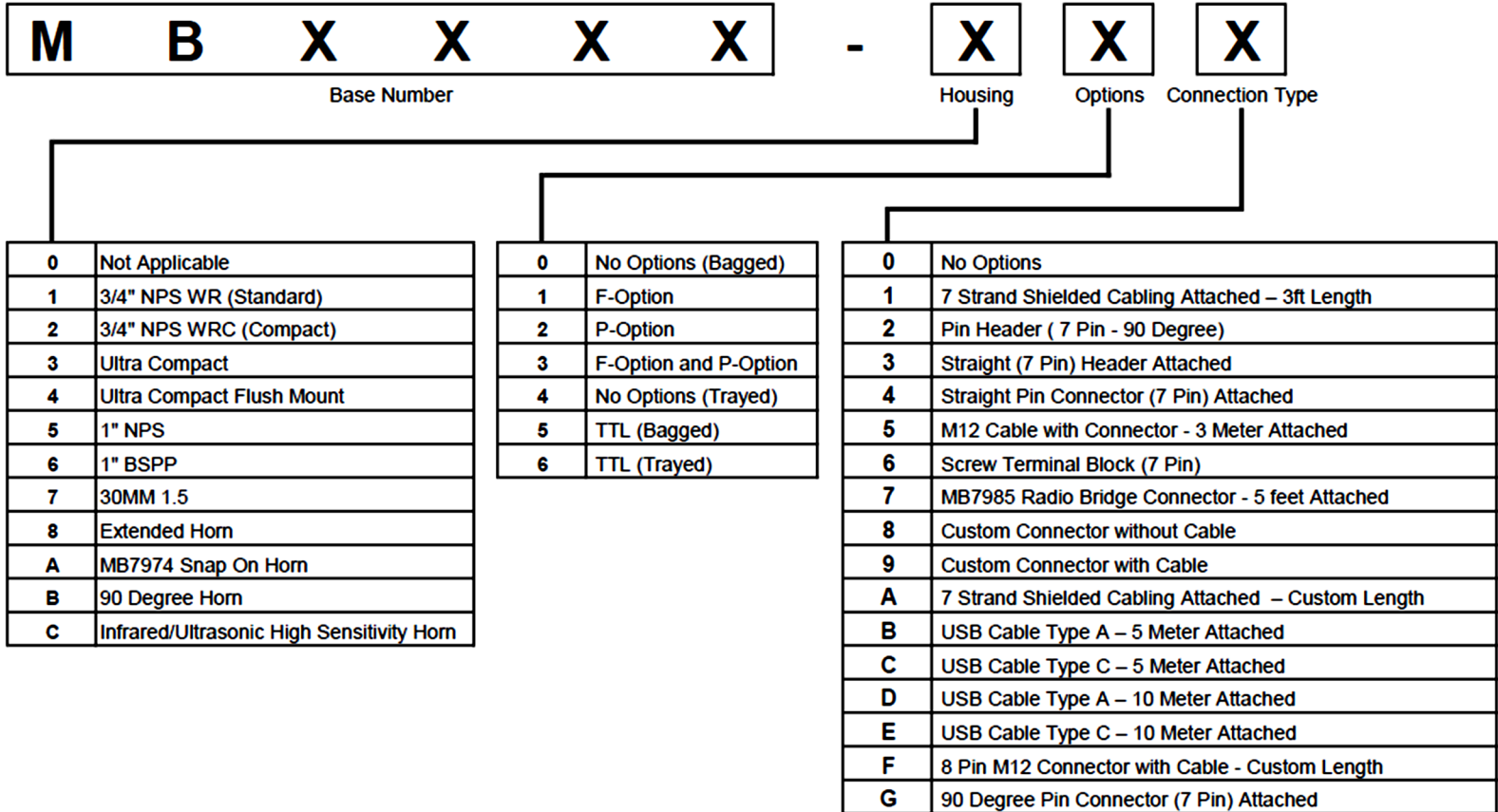

The following tables display all of the active and valid part numbers for these products.

Active Part Numbers for MB7360				
MB7360-1XX	MB7360-2XX	MB7360-5XX	MB7360-6XX	MB7360-7XX

Active Part Numbers for MB7380				
MB7380-1XX	MB7380-2XX	MB7380-5XX	MB7380-6XX	MB7380-7XX

The legacy part numbers MB7367 and MB7387 are now contained within MB7360 and MB7380 which are the base for all housing options on these products. To select a product with a legacy part number, select the desired housing option on the product with the appropriate base. Please review the following table for more information.

IF YOU BOUGHT	NOW BUY	
Legacy Part Number	Base and Housing	Active Part Number
MB7367– Compact	MB7360 in 3/4" NPS WRC Housing	MB7360-2XX
MB7367– 1" NPS	MB7360 in 1" NPS Housing	MB7360-5XX
MB7367– 1" BSPP	MB7360 in 1" BSPP Housing	MB7360-6XX
MB7367– 30mm 1.5	MB7360 in 30mm 1.5 Housing	MB7360-7XX
MB7387– Compact	MB7380 in 3/4" NPS WRC Housing	MB7380-2XX
MB7387– 1" NPS	MB7380 in 1" NPS Housing	MB7380-5XX
MB7387– 1" BSPP	MB7380 in 1" BSPP Housing	MB7380-6XX
MB7387– 30mm 1.5	MB7380 in 30mm 1.5 Housing	MB7380-7XX

Active Part Numbers for MB7363, MB7366, MB7368		
MB7363-1XX	MB7366-1XX	MB7368-1XX
MB7363-8XX	MB7366-8XX	MB7368-8XX

Active Part Numbers for MB7369				
MB7369-1XX	MB7369-2XX	MB7369-5XX	MB7369-6XX	MB7369-7XX

Active Part Numbers for MB7383, MB7386, MB7388		
MB7383-1XX	MB7386-1XX	MB7388-1XX
MB7383-8XX	MB7386-8XX	MB7388-8XX

Active Part Numbers for MB7389, MB7375, MB7395				
MB7389-1XX	MB7389-2XX	MB7389-5XX	MB7389-6XX	MB7389-7XX
MB7375-1XX	MB7375-2XX	MB7375-5XX	MB7375-6XX	MB7375-7XX
MB7395-1XX	MB7395-2XX	MB7395-5XX	MB7375-6XX	MB7395-7XX

After reviewing this datasheet, do you have any more questions?

We offer Technical Support on all of our products even if you purchased them through one of our many vendors worldwide.

You can **fill out a Technical Support form** for assistance on a sensor here --> [Technical Support](#)

Not sure which sensor you need for your application?

We offer Sensor Selection Assistance, click the link here to fill out a form for support --> [Sensor Selection Help](#)

Looking for tutorials to help you get started?

[Frequently Asked Questions about Our Sensors](#)

We receive many questions about our products and services. This resource offers answers to common inquiries we receive about our product lines and their application.

[Fully Calibrated Beam Patterns](#)

All of our sensors are factory calibrated to provide consistent beam patterns, detection zones, to fit into a wide variety of applications. In our product lines, each model number comes with a different beam pattern that reflects the sensitivity and the detection zone of how it sees a target. Additionally, we strive to maintain consistency between our finished products, and you will see little to no deviation between sensors of the same model. This allows you to have confidence in your final application when using multiple sensors.

[Understanding Range Readings](#)

The success of an application may hinge upon knowing the exact location of a target. However, a sensor may report one meter even if the target is not exactly one meter away from the sensor. Sensor specifications, such as resolution, precision, and accuracy, help you to understand sensor performance.

Contact us now with any questions at sensors@maxbotix.com or call +1-218-454-0766.

Please call during our preferred business hours of 8:00 am – 4:30 pm EST on Monday through Thursday and 8:00 am – 2:00 pm EST on Friday, or you may leave us a voicemail anytime.